



# DEPARTMENT OF PUBLIC WORKS

Kurt Bradburn  
Mayor

Matthew Huish  
Chief Administrative Officer

Michael Gladbach, P.E.  
Director

## Memorandum

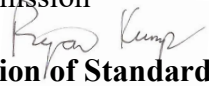
**DATE:** February 12, 2021  
**TO:** City Council via the Planning Commission  
**FROM:** Ryan C. Kump, P.E., City Engineer   
**SUBJECT:** **Project Name: Review and Adoption of Standard Specifications and Details for Municipal Construction**  
**Plan Case Number: CODE-02-21-5989**

---

In 2018, the City Council approved Ordinance 18-03, which adopted the City's Standard Specification and Details for Municipal Construction. The city is required to update these on a regular basis, bringing all significant changes that impact development requirements back for council approval. The 2021 update to the Standard Specifications and Details for Municipal Construction have several edits and additions. These include:

- TS-04
  - o Added note to clarify 'L' shaped corners, 90 degree roadway turns, require sight triangles at corner
- TS-05
  - o Increasing cul-de-sac radius from 46' to 48', to match International Fire Code
  - o Adjusting fire hammerhead to correct min width of 27' on main stem
  - o Clarifying note 3 – signage may be required
  - o Adding new knuckle detail
- DA-01 through 05
  - o Revised maximum allowed driveway slope from 12% to 10% to match International Fire Code. Still allows for slopes up to 15% with City Engineer approval.
- SW-03
  - o Clarified note 7 regarding minimum sidewalk width requirements
- CG-04
  - o New detail for curb and gutter inlet installation

- CG-05
  - o New detail for open irrigation ditch to curb and gutter transition. This is mostly seen in historic Sandy
  
- RC-03
  - o New detail for Narrow Trench Excavation requirements. This is a new method of fiber optic installation being used primarily by Google Fiber
  
- Part 7.0B Public Utilities Development Standards and Requirements
  - o Full document edit and modifications to incorporate new Low Impact Development (LID) standards
  
- Part 7.0B Storm Water Design Criteria
  - o Brand new section, split out of part 7.0A, that fully incorporates LID storm water standards, meeting new state and federal requirements.

The Sandy City Public Works and Public Utilities Department recommend that the Planning Commission forward a positive recommendation to the City Council to adopt the proposed changes to the Sandy City Standard Specifications.

# BIORETENTION FEATURES

Bioretention areas are often shallow, landscaped areas that receive and treat stormwater. Runoff is allowed to pond on the surface of the bioretention area, typically a foot to 18 inches deep, where it can then filter through a vegetative layer and engineered soil media to remove sediment and pollutants. In locations of well drained subsoils, the water may then infiltrate into the subgrade. At sites or locations that will not allow for infiltration, flow-through systems are required; underdrains are installed beneath the planting soil to drain the facility and release the treated water to a conveyance feature or storm drain system. Bioretention areas are very versatile facilities that can fit a wide range of settings.



Bioretention areas are among the most common LID techniques implemented, often in highly visible locations, and can be a valuable educational opportunity especially if signage is installed illustrating function, intent, or native plants.

## Retrofit Opportunities



### Benefits

- Applicable to a wide range of sites and layout, easily integrated into urban retrofit projects
- Provides reliable water quality improvement and facilitates evapotranspiration
- Attenuates peak flows; reduces runoff volume and recharges groundwater when infiltration possible
- Provides greening and reduces heat island effect in urban areas
- Provides aesthetic amenity and creates habitat

### Potential Constraints

- Infiltration design requires sufficiently permeable soils, depth to groundwater/hardpan; underdrain system increases cost and maintenance
- Vegetation requires maintaining
- Vegetation will require dry season irrigation
- Ratio of Impervious to pervious shall not exceed 20:1; divide larger watersheds among dispersed features

### Siting Applications

- Residential yards
- Office and commercial store fronts
- Roadway medians, bulb-outs, and traffic circles
- Parking lot islands, cul-de-sacs
- Parks and other landscaped areas

## Technical Information

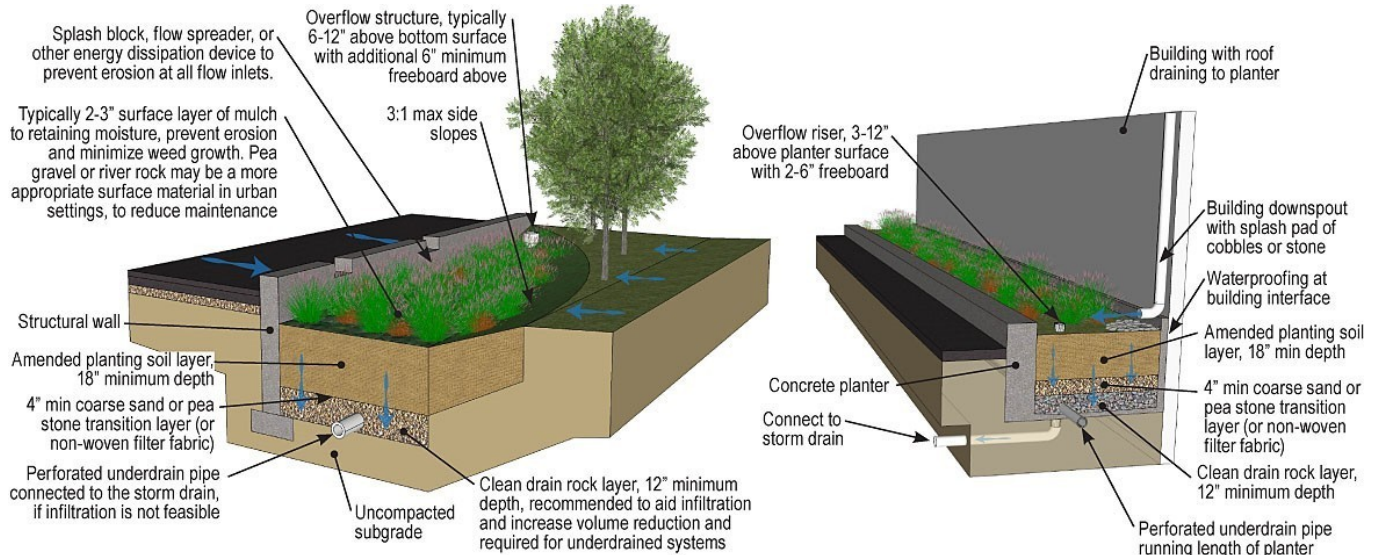

Figure: Bioretention feature typical details

## Design & Sizing Criteria

- Bioretention features are composed of an engineered media layer that is typically about 18" deep (to allow plant development) over an aggregate layer with a void ratio of approximately 40%, which provides subsurface storage volume. Increasing the depth of the storage gallery is a cost-effective way to increase performance of the bioretention area.
- Bioretention areas can be sized as either volume-based or flow-based systems (or a combination) to capture runoff from a contributing area much larger than the footprint.
- Volume-based systems are sized to capture the water quality volume within the surface ponding area and void space of the drain rock storage layer and should release all captured runoff within a maximum 48-hour drawdown time (either by subgrade infiltration or through an underdrain).
- Flow-based systems are sized to percolate the water quality flow through the bottom of the facility. The surface area of the system multiplied by the infiltration rate of the planting media (which should be considered as 5 in/hr. for design) must equal or exceed the water quality flow. The subgrade infiltration rate must be high enough to process this flow as well, or an underdrain is necessary.
- Reliance on subgrade infiltration requires a minimum soil infiltration rate of 0.5 in/hr., in addition to the above requirements. IF GI is planned for impermeable soils (HSG C and D), an underdrain should be installed.
- If the separation from the bottom of the facility to the seasonally high groundwater elevation is less than 10 feet then an underdrain should be installed, with an impermeable liner placed beneath all system media.
- Infiltrating bioretention systems should be placed a minimum of 10 feet from building foundations and 100 feet from drinking water wells. If located in an area with heavy traffic, use of structural curbs and tie-beams are recommended to ensure that any impact loads are distributed evenly.
- Pre-treatment (vegetated buffer strip, swale, sediment forebay) can improve function and ease maintenance.
- Portions of runoff from storms larger than the design storm may bypass the bioretention and be diverted to the storm drains system.



### Pollutant Removal

- Suspended pollution is removed by infiltration. Almost all solids are removed in the upper few inches of the soil surface.
- Dissolved pollution is removed by chemical precipitation or absorption to soil/media. Plant roots remove dissolved pollution by vegetation uptake.

### Water Quality Considerations

- Anoxic (low oxygen) conditions can remove some pollutants (nitrates) but also promote leaching (TP and organic matter).
- Soil or engineered media should have low phosphorus content.
- Bioretention with good drainage below the frost line will function in cold weather.
- Snowmelt infiltration with de-icing chemicals can contaminate groundwater and impact vegetation that is not salt tolerant.
- Bacteria can survive longer in the soil at low temperatures.
- Pollution removal is more effective at low influent concentrations.

### Performance

- Effective treatment for all pollutants except for influent high in phosphorus, which result in gain.
- Bioretention monitoring in Colorado shows less reduction compared to 2016 summary statistics except for TSS.
- USU monitoring in Logan and Salt Lake City has similar results as Colorado for phosphorus.

#### BIORETENTION MONITORING RESULTS FROM 2016 SUMMARY STATISTICS (WERF 2017)

	<b>E. COLI (cfu/100 ml)</b>	<b>TOTAL PHOSPHORUS (mg/L)</b>	<b>TOTAL NITROGEN (mg/L)</b>	<b>TOTAL SUSPENDED SOLIDS (mg/L)</b>
Inflow*	1200 (110-5900, n=7)	0.13 (0.12-0.17, n=30)	1.24 (0.77-2.25, n=17)	40.6 (18-99.2, n=25)
Outflow*	240 (18-1100, n=7)	0.13 (0.08-0.19, n=30)	1.04 (0.65-2.08, n=17)	10 (4-18.5, n=25)

\*Inflow and Outflow are median values (interquartile range, sample size).

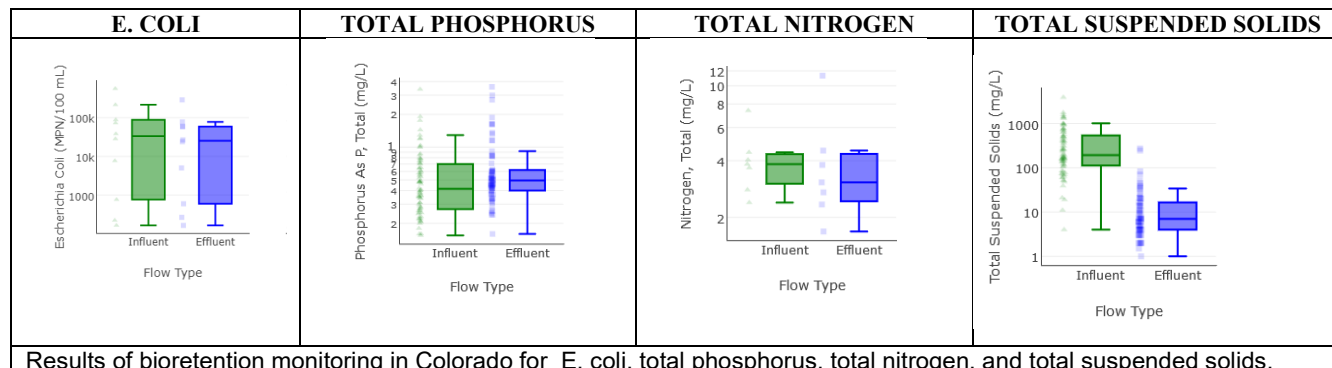

# PERMEABLE PAVEMENTS

Permeable pavement refers to any porous, load-bearing surface that allows direct rainfall and runoff to pass through the surface layer and be temporarily stored in a storage layer filled with aggregate. Ideally, site conditions will allow the subsurface storage layer to drain by infiltration into the subsoils or be released through an underdrain. The permeable pavement system itself will provide some water quality benefits by filtering sediments and some other pollutants. It will also reduce peak flows due to detention in the rock layer. Infiltration functions as the primary mechanism for stormwater treatment and volume reduction. Systems which use underdrains will provide reduced benefits such as peak flow mitigation. When properly constructed, porous pavements are durable, low maintenance, and have a low life-cycle cost.



Since they replace traditional hard surfaces, permeable pavement is easily integrated into developed areas. The wide variety of surface types provide diverse options for either matching or enhancing the character of an existing site.

## Retrofit Opportunities



### Benefits

- Reduces runoff volume and facilitates groundwater recharge (infiltration-based systems only)
- Easily integrated into existing infrastructure and retrofits
- Reduces the heat island effect and frequency/mass of salt application during winter
- Can be used as a designelement to provide aesthetic benefits
- Helps with peak flow attenuation
- Longer lifespan and lower lifecycle operations and maintenance cost compared to conventional paving
- Lack of ponding improves safety for pedestrians and cyclists

### Potential Constraints

- Not recommended for roads with high-speed traffic or frequent turning
- Construction costs can be greater than for conventional paving
- Will require additional maintenance when exposed to regular high-volume traffic
- Storage and infiltration are only effective on relatively flat sites with slopes less than 10%, as level subgrade must be achieved
- Likely not effective as a treatment method if infiltration to the subgrade is not an option
- Ratio of Impervious to pervious shall not exceed 5:1

### Siting Applications

- Parking lots or parallel parking strips or lanes
- Driveways and low traffic roads
- Sidewalks and pathways
- Golf cart paths
- Park hardscape
- Plazas, patios, or terraces
- Main arterial roads

## Technical Information

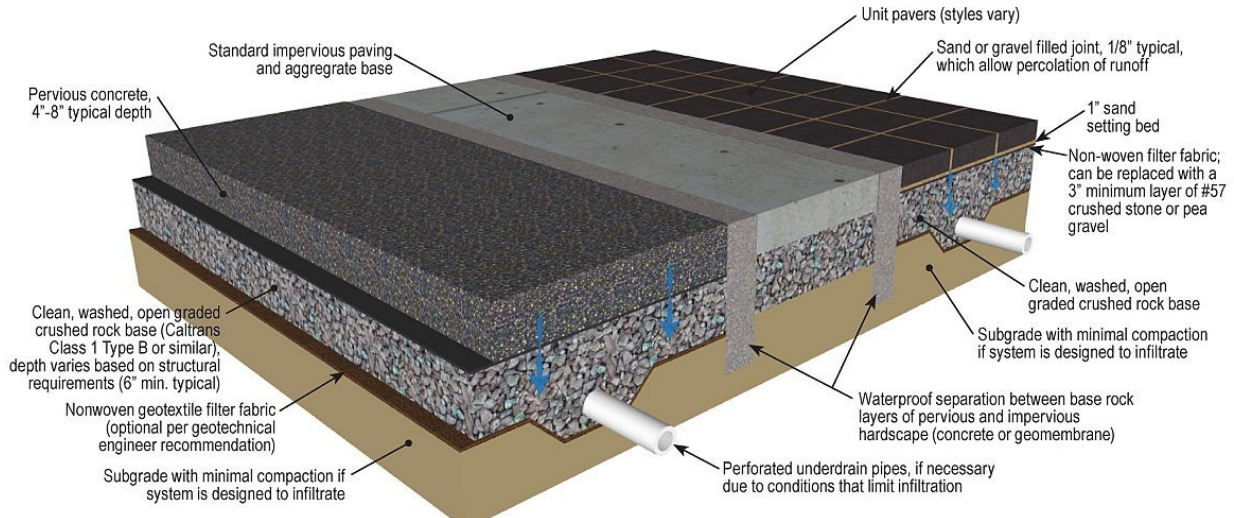

Figure: Pervious concrete and permeable pavers typical details

## Design & Sizing Criteria

- Permeable pavements are volume-based systems sized to capture stormwater runoff within the void space of the subsurface storage layer and should fully drain all stored runoff within a maximum 72-hour drawdown time.
- Infiltration-based systems (which provide treatment and volume reduction) must have a minimum subgrade soil infiltration rate of 0.5 in/hr.; underdrains should be used in impermeable soils (HSG C and D) that do not meet this standard. If infiltration exceeds 2.5 in/hr.
- Infiltration requires a minimum 10-foot separation between the bottom of the drain rock layer and the seasonally high groundwater elevation. For areas with inadequate separation or where the groundwater is contaminated, an underdrain should be used with an impermeable liner placed beneath the rock.
- Infiltration-based systems should be placed a minimum of 10 feet from building foundations and a minimum of 100 feet from drinking waterwells.
- Tributary areas should contribute runoff with low levels of sediment to avoid clogging the surface layer. If drainage will come from pervious or un-stabilized areas, appropriate pre-treatment measures should be implemented to filter the runoff before reaching the permeable pavement.
- To ensure proper system function, it is essential that permeable pavements (especially poured in place systems) are installed properly by a contractor with prior experience and certification.

## Pavement Types

There are several types of permeable pavement available, including those that are poured in place (such as pervious concrete and porous asphalt) and modular paving systems (such as permeable interlocking concrete pavers, unit stone or brick pavers, or reinforced turf type systems).

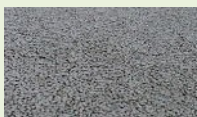

Pervious Concrete

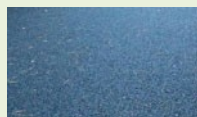

Porous Asphalt



Permeable Pavers



Reinforced Turf

### Pollutant Removal

- Filters and traps pollution in pavement pores and underlying base material.
- Bacteria in soil act as predators of coliform.
- Some cold weather studies indicate performance of permeable pavement is comparable to wetland ponds in regard to bacteria, nutrients, and sediment removal.

### Water Quality Considerations

- Maintains infiltration and treatment abilities during cold temperatures, resistant to freezing, thaws quickly.
- Best used in combination with other GI to pretreat influent water.
- Surface maintenance (i.e. sweeping) is critical to maintain perviousness and ability to remove pollution from runoff.
- Sweeping should occur monthly. Vacuuming and power washing should occur 2-3 / year.

### Performance

- Available data show effective treatment for TP and TSS.
- No influent data to measure performance for E. coli Median effluent is ~1,000 cfu and similar or lower than E. coli effluent measured from other GI, indicating reasonable treatment.
- Monitor results from Colorado monitor sites indicate better performance than 2016 summary statistics.

### PERMEABLE PAVEMENT MONITORING RESULTS FROM 2016 SUMMARY STATISTICS (WERF 2017)

	E. COLI (CFU/100 ML)	TOTAL PHOSPHORUS (MG/L)	TOTAL NITROGEN (MG/L)	TOTAL SUSPENDED SOLIDS (MG/L)
Inflow*	-	0.19 (0.12-0.36, n=8)	-	93.7 (36.8-243, n=9)
Outflow*	-	0.11 (0.07-0.2, n=8)	-	26 (15-53.2, n=9)

\*Inflow and Outflow are median values (interquartile range, sample size).

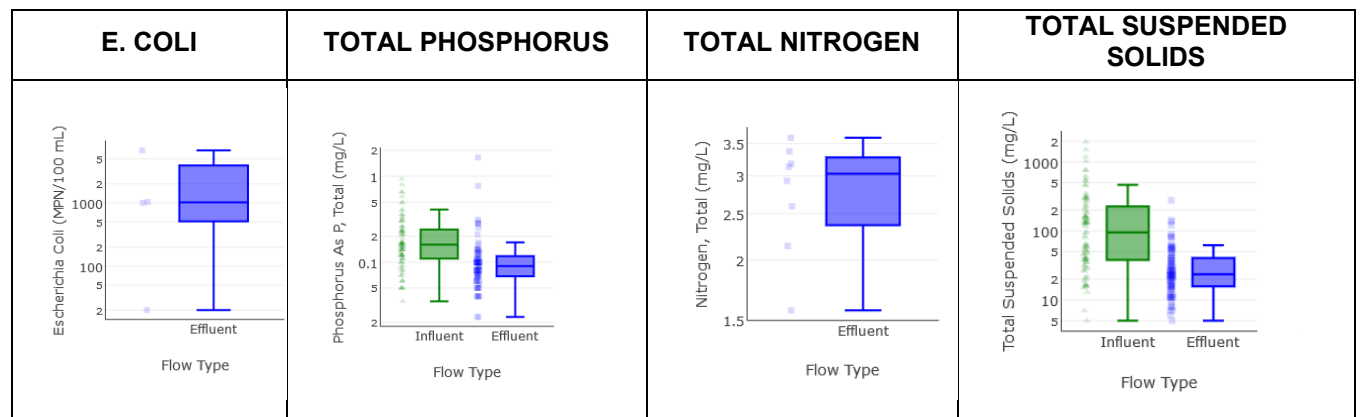

Results of permeable pavements monitoring in Colorado for E. coli, total phosphorus, total nitrogen, and total suspended solids.



# WETLANDS, DRY OR WET PONDS

Constructed wetlands are man-made systems that typically have multiple shallow permanent pools of water at varying depths, incorporating both emergent wetland plants and open water areas. Though possessing less biodiversity than natural wetlands, they still offer significant habitat enhancement and aesthetic value while being optimized for stormwater treatment. These facilities are among the most effective at removing pollutants from stormwater. Constructed wetlands provide water quality benefits through settling, microbial transformation, and plant uptake. Treatment primarily occurs in the root zone and soil media, where nutrients and dissolved pollutants are removed.



Though more technically complex, constructed wetlands have the potential to provide the most water quality improvements of any naturalized system.

## Retrofit Opportunities



## Benefits

- Effective at removing a broad spectrum of pollutants commonly found in urban runoff
- Reduces stormwater peakflows
- Provides substantial habitat
- Attractive landscape feature, well suited as an open-space amenity
- Good in areas unsuitable for infiltration or with high groundwater table
- Easily customizable to various sizes and dimensions, based on site, budget, and design intent

## Potential Constraints

- Space requirement
- Standing water may represent safety concern
- Mosquito breeding is likely to occur, requiring vector control
- Cannot be placed on steep or unstable slopes
- Base flow or supplemental water source needed in dry season if water level is to be maintained
- Possible aesthetic concerns related to vegetation appearing dead or unkempt in winter and summer
- Ratio of Impervious to pervious shall not exceed 20:1;

## Siting Applications

- Parks, open spaces, and golf courses
- Commercial, industrial, or residential developments
- Regional detention & treatment

## Design Variation

A subsurface flow wetland has no open water and runoff is directed beneath the surface through a planted substrate. They generally require less surface area and have fewer vector issues but may be more expensive to construct and maintain.

## Technical Information

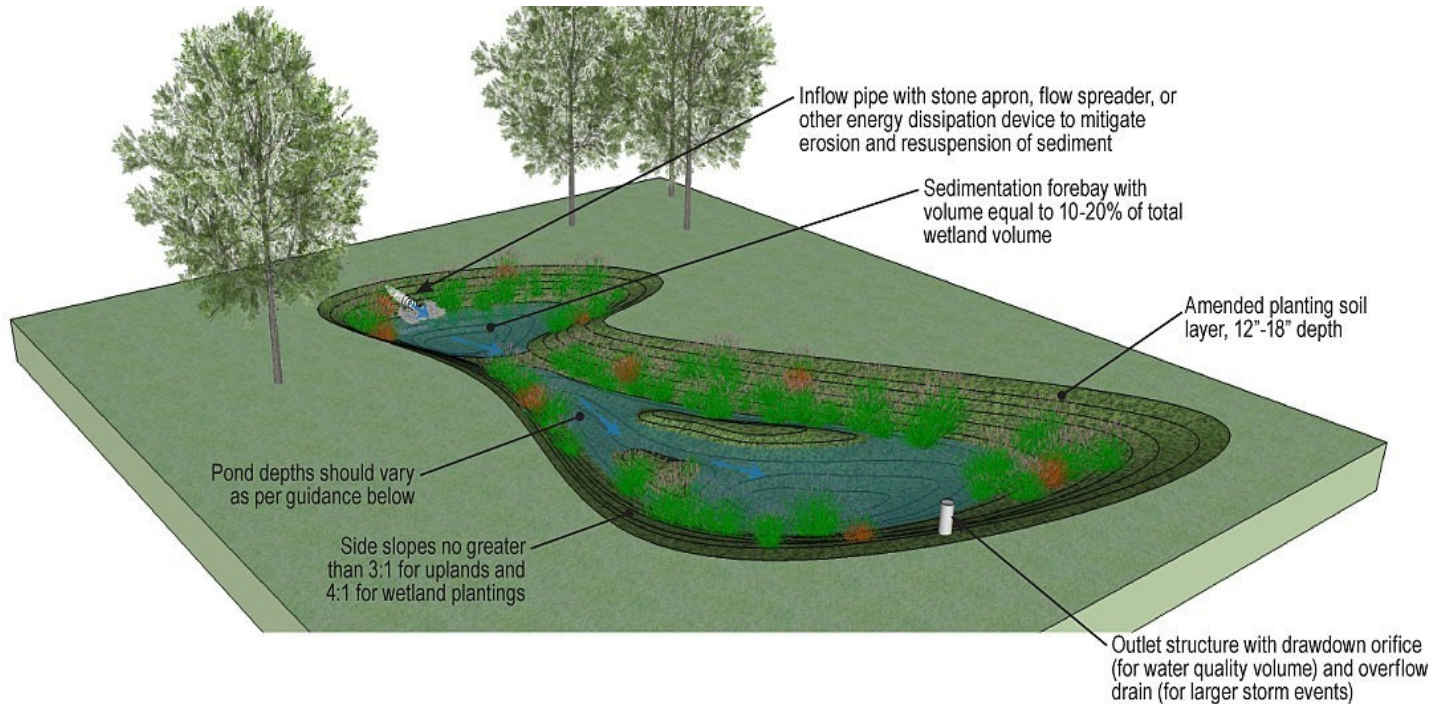
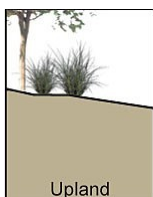

Figure: Constructed wetland typical detail

### Design & Sizing Criteria

- Constructed wetlands are volume-based systems sized to capture the water quality volume and discharge it from the outlet within 24 hours.
- The health of wetland vegetation is integral to the ability of stormwater wetlands to improve water quality. Wetlands should have zones of both very shallow (less than 6 inches) and moderately shallow (6 to 18 inches) standing water to maintain both vegetated and open water areas, with maximum depths of about 5 feet.
- To enhance pollutant removal, wetlands should feature "complex microtopography" in which the underwater surface varies in elevation to increase the length of flow paths for runoff.
- The minimum length to width ratio should be 2:1, though 4:1 is preferred.
- Open water should occupy 25-50% of the surface.
- Pre-treatment, which occurs via settling in a forebay, will greatly aid the function of constructed wetlands. Additional upstream BMPs may also be used to enhance treatment effectiveness.
- Stormwater wetlands require a large contributing area to maintain a permanent pool, typically at least 5 acres.
- In areas with well-draining soils (HSG A or B) an impermeable liner and/or a larger contributing area may be necessary to maintain standing water.
- Wetlands may intersect the groundwater table, which will help maintain the permanent pool. This should be avoided in areas where stormwater or the groundwater may be contaminated. In these areas, an impermeable liner should be utilized.

### Plant Selection (See Appendix A)



-Edge & small islands  
-3:1 max side slope  
-Inundated by runoff

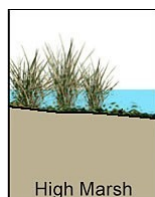

-Water depth ≤ 6"  
-4:1 max side slope  
-May dry in summer

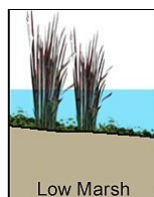

-Water depth 6"-18"  
-5:1 max side slope  
-Emergent plants

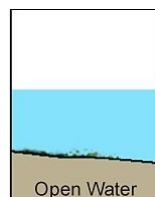

-Water depth ≤ 5'  
-25-50% of total area

### Plant Selection

Wetlands, with their variety of water depths and topography, will require a more diverse and extensive plant palette than other BMPs. Most locations will require plants suitable for prolonged standing water and, due to the permanent pool, it is also acceptable to use plants with higher irrigation demand.

### Pollutant Removal

- Particle settling and sedimentation.
- Chemical processes that precipitate nutrients and other pollution.
- Biological uptake by plants, algae, and bacteria.

### Water Quality Considerations

- Standing water can provide opportunity for algae growth, decomposition, and anoxic conditions.
- Wetlands can provide more water quality benefits compared to any other natural water feature.
- Ability to remove pollution decreases during the winter season in Utah.

### Performance

- Results show water quality benefits for all parameters, including substantial reductions for E. coli and total suspended solids.
- No influent E. coli measurements available for Colorado sites. Median value of effluent is below recreational standard in Utah

### WETLANDS/WET DRY POND MONITORING RESULTS FROM 2016 SUMMARY STATISTICS (WERF 2017)

	<b>E. Coli (cfu/100 ml)</b>	<b>Total Phosphorus (mg/L)</b>	<b>Total Nitrogen (mg/L)</b>	<b>Total Suspended Solids (mg/L)</b>
<b>Inflow*</b>	2800 (650-15000, n=10)	0.16 (0.1-0.27, n=75)	1.48 (1.02-2, n=37)	31 (13.1-75.9, n=78)
<b>Outflow*</b>	1000 (260-3800, n=10)	0.12 (0.07-0.22, n=75)	1.42 (1.02-1.82, n=37)	14.1 (4.7-31, n=78)

\*Inflow and Outflow are median values (interquartile range, sample size).

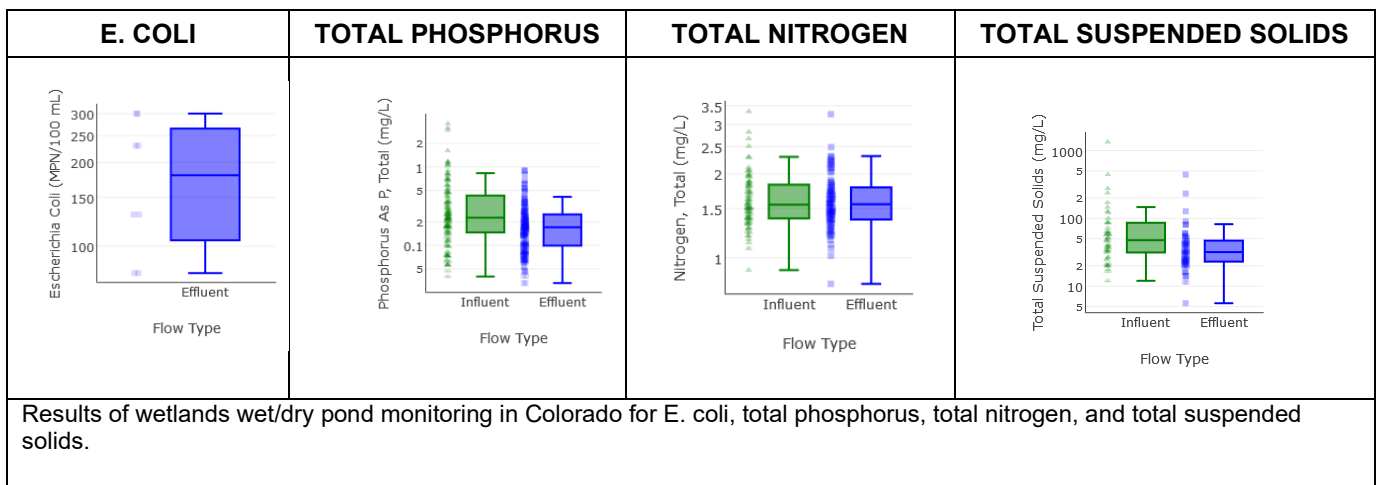



# VEGETATED SWALES

Vegetated swales are shallow stormwater conveyance channels with vegetation covering the side slopes and bottom. Treatment occurs as runoff flows through the vegetation and infiltrates into the soil. Swales can be designed as part of stormwater conveyance system and can eliminate the need for some curbs, gutters and storm drains, while providing onsite treatment from road runoff. They are also well suited to treat runoff from roads and highways because of their linear nature. The treatment effectiveness is correlated to the residence time of the runoff in the swale, and therefore, flow-based swales tend to be considerably longer than other types of treatment BMPs.



Vegetated swales, such as this installed in a parking lot, can both treat and convey runoff, eliminating the need for some catch basins and pipes.

## Retrofit Opportunities



### Benefits

- Can convey stormwater, including within street right-of-way
- Low installation and maintenance costs
- Reduces peak flows and velocity compared to concrete lined or piped conveyance
- Improves water quality, depending on site constraints, by removing sediment, suspended solids, and trace metals
- Vegetation provides aesthetic benefit and reduces the heat island effect in urban areas

### Potential Constraints

- Larger space requirements than traditional conveyance methods
- Requires regular vegetative maintenance and trash removal
- Can be difficult to locate in retrofit applications
- Not suitable for areas with steep slopes or highly erodible soils
- Limited to relatively small drainage areas, generally less than 5 acres
- Limited volume reduction and peak flow attenuation, unless designed with check dams
- Need protection from salt and sand application during the winter

### Siting Applications

- Road shoulders and medians
- Parking lot islands
- Commercial, industrial, and residential developments
- Open space and parks



## Technical Information

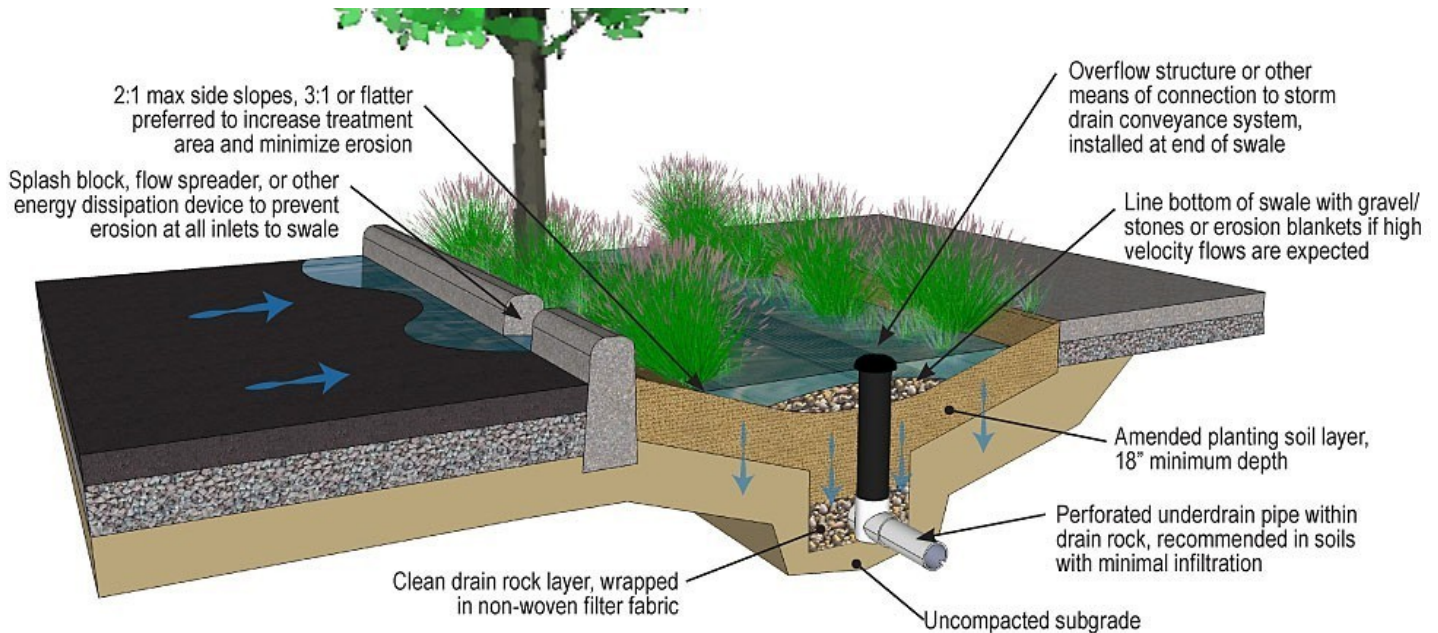

Figure: Vegetated swale typical detail

## Design & Sizing Criteria

- Swales are flow-based systems sized to convey the stormwater runoff at a flow velocity not exceeding 1 foot per second and maximum water depth not exceeding the lesser of 6 inches or 2/3 of the vegetation height.
- Swales must provide a minimum of 10 minutes of stormwater residence time for pollutant removal, with a minimum length of 100 feet.
- The preferred longitudinal slope is 1-2% to limit flow velocity. Check dams placed across the flow path can promote additional infiltration and flow reduction and should be used for longitudinal slopes exceeding 5%.
- Swales should generally have a trapezoidal or parabolic shape to promote even flow across the whole width of the swale. The bottom width should be between 2 and 10 feet.
- A dense and well-maintained vegetative cover on the swale bottom and side slopes filters pollutants out of runoff and helps reduce flow velocities and protect the swale from erosion. Stones or gravel may also be used on the bottom to protect against erosion.
- Vegetated swales that are primarily designed to detain runoff (behind check dams or due to layout) should be considered bioretention facilities and designed accordingly.
- Most effective on soils that allow infiltration. In impermeable soils, installing well-drained planting media with an underdrain beneath is recommended.

### Pollutant Removal

- Vegetation traps suspended particles and promotes infiltration.
- Deposition of solid particles to the soil surface.
- Plant roots remove dissolved pollution by vegetation uptake.

### Water Quality Considerations

- Filtering capacity of pollution is influenced by surface slope and maintaining vegetation cover.
- Soil properties must be conducive to vegetation growth and infiltration.
- Dense vegetation is ideal but must thrive in Utah. Vegetation should be taller than peak flow depth.
- Create maximum exposure to vegetation without impounding flow.

### Performance

- Available data show increase in pollution for most parameters.
- Summary stats show removal of TSS is less at low concentrations (25<sup>th</sup> percentile) and increases for median-higher concentrations.
- Monitor results from Colorado show substantial decrease in TSS.

### BIO SWALE MONITORING RESULTS FROM 2016 SUMMARY STATISTICS (WERF 2017)

	<b>E. COLI (CFU/100 ML)</b>	<b>TOTAL PHOSPHORUS (MG/L)</b>	<b>TOTAL NITROGEN (MG/L)</b>	<b>TOTAL SUSPENDED SOLIDS (MG/L)</b>
Inflow*	3500 (410-11000, n=5)	0.12 (0.07-0.25, n=23)	0.76 (0.44-1.5, n=8)	28.6 (9.2-67.5, n=24)
Outflow*	4400 (1200-11000, n=6)	0.2 (0.11-0.29, n=23)	0.85 (0.54-1.6, n=8)	24 (11-46.7, n=24)

\*Inflow and Outflow are median values (interquartile range, sample size).

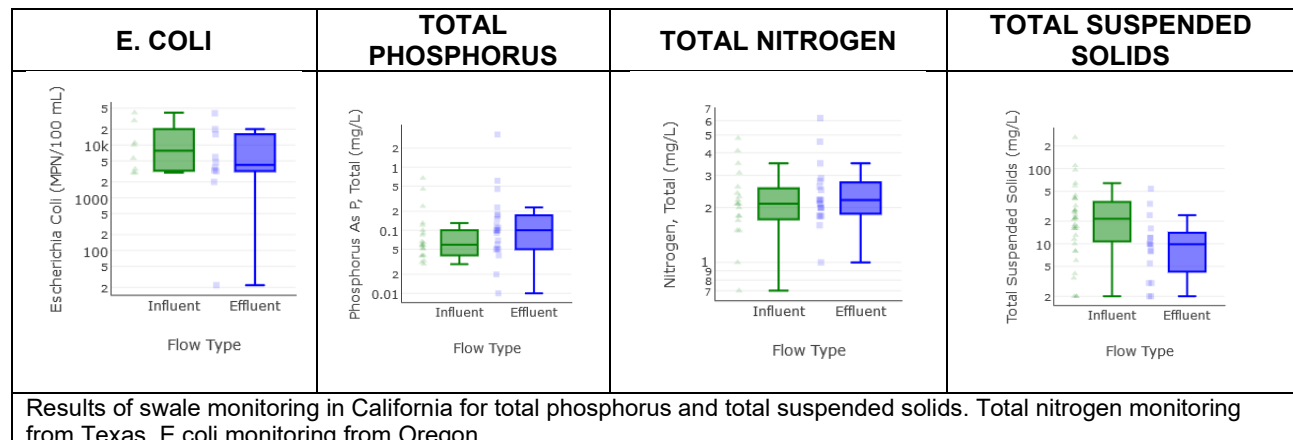

# UNDERGROUND DETENTION & INFILTRATION SYSTEMS

Designed and constructed as surface or subsurface features, detention/infiltration basins capture and control discharge of stormwater. These systems can remove pollutants by using sediment traps and filtering through the underlying soils. An infiltration trench is a long, narrow, rock-filled trench with no outlet that receives stormwater runoff from contributing areas. A dry well is a small rock-filled pit that usually receives runoff from rooftops or other impervious areas with low sediment loading. Water is stored in the void space between the stones and percolates through the underlying soil matrix. If high sediment loads are expected, pretreatment is desirable to reduce the maintenance burden.



Underground infiltration systems can be integrated into a site to enhance and diversify the landscaping, in addition to providing stormwater improvements.

## Retrofit Opportunities

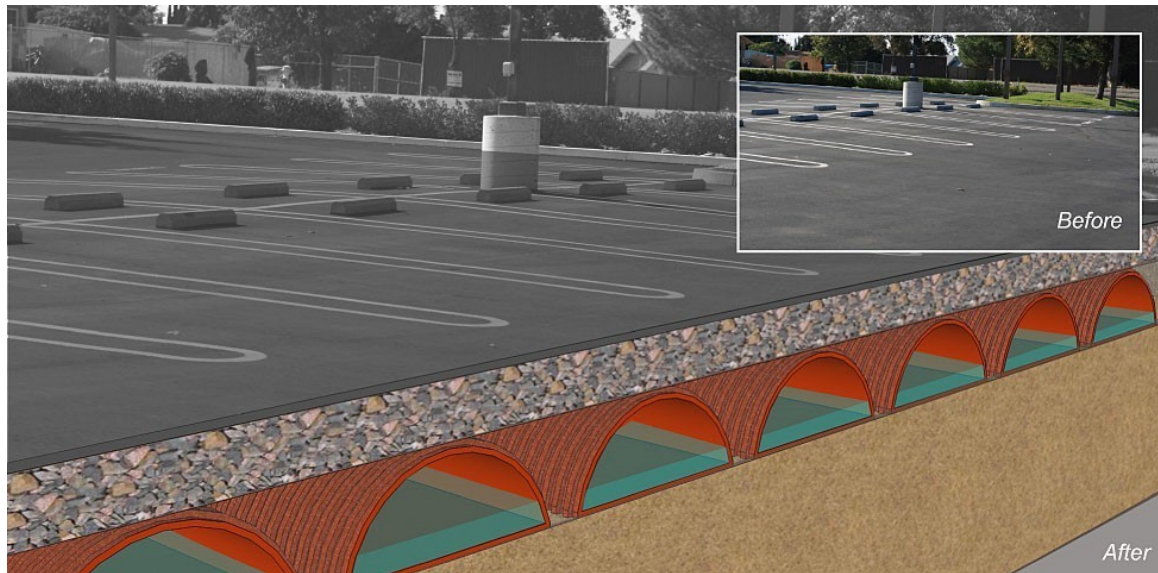

### Benefits

- Reduces runoff volume and attenuates peak flows
- Improves water quality - good for removing fine sediment and adsorbed pollutants
- Enhances groundwater recharge and contributes to stream base flow
- Minimal surface space requirements; located underground and thus visually unobtrusive
- Low construction and maintenance costs

### Potential Constraints

- Requires permeable subgrade soils, not recommended for HSGs Types C or D
- Requires groundwater separation
- Contributing area should generally be less than 5 acres
- Not suitable on fill sites, steep slopes (>15%), contaminated soils, industrial sites, or sites where spills are likely to occur
- May encounter siting challenges in urban retrofit areas due to foundation setback, utilities, and poor soil conditions
- Liquefiable soils would require additional improvements

### Siting Applications

- Mixed-use and commercial
- Roads and parking lots
- Parks and open spaces
- Single and multi-family residential



## Technical Information

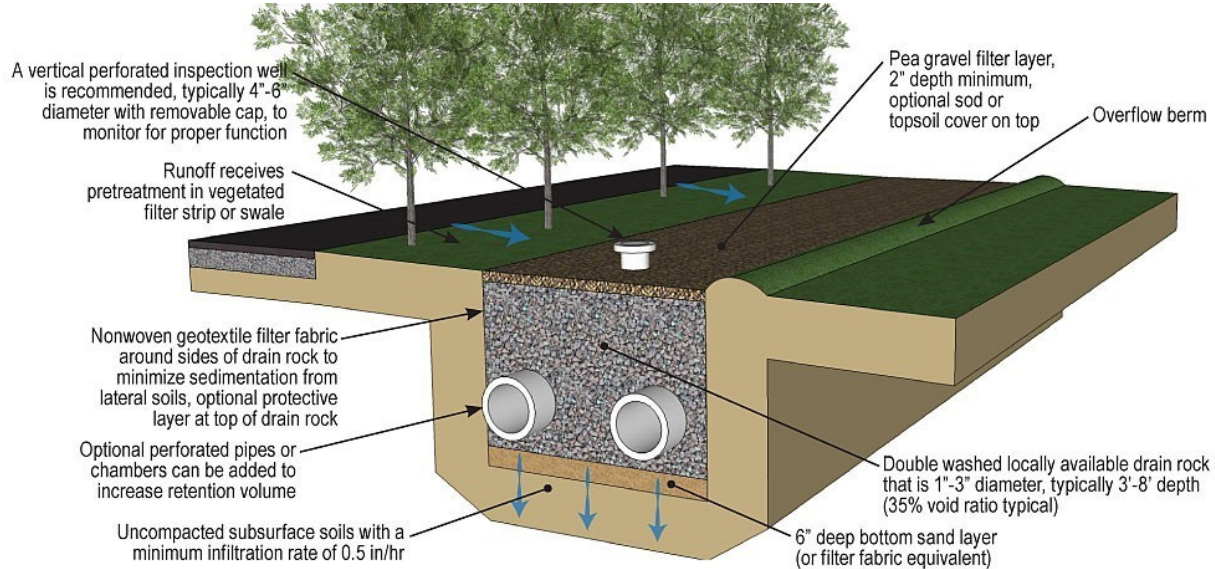

Figure: Infiltration trench typical detail

## Design & Sizing Criteria

- Detention and infiltration facilities are volume-based systems sized to capture the water quality volume within the void space of the storage layer and should infiltrate all stored runoff into the subsoils within a maximum 72-hour drawdown time.
- Likely require a box-like concrete structure, which provides a void ratio of 90% (at a higher cost) or storage galleries that provide a void ratio of approximately 40% (at a lower cost).
- Requires a minimum subgrade soil infiltration rate of 0.5 in/hr. minimum. If soil infiltration rates exceed 2.5 in/hr., runoff should be fully treated (with one or more upstream BMPs) prior to infiltration to protect groundwater quality.
- Requires a 10-foot minimum separation from the bottom of the facility to the seasonally high groundwater elevation.
- Should be placed a minimum of 10 feet from building foundations and 100 feet from drinking water wells.
- Should be installed with a flat bottom to promote uniform infiltration.
- To help prevent clogging and ease maintenance, it is important to provide upstream pre-treatment (using filter strips, swales, forebays, or manhole sumps) to remove coarse sediment, particles, and oils.
- If possible, system should be designed to avoid classification as a Class V injection well, which requires submission of an inventory form to the EPA. A Class V injection well is deeper than it is wide.
- If infiltration is not possible, can be installed with an orifice to provide flow and volume control functions without any water quality treatment.

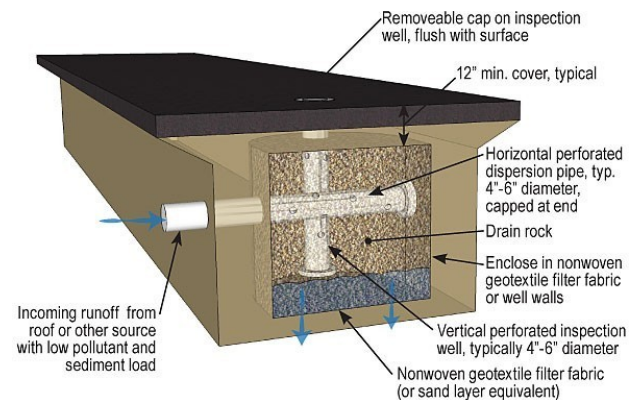

Figure: Dry well typical detail

## Proprietary Systems

There are many retention systems designed to maximize subsurface capture volume and that include components for pretreatment and flow control.



*Cudo Cubes are an example of a typical modular block system.*



*Triton stormwater chambers are a typical semi-circular linked chamber system.*

Note: Proprietary systems are included for representative purposes only and are not an endorsement of any specific product.



### Pollutant Removal

- Underground Storage Systems (USS) settle suspended pollution as runoff collects.

- Infiltration in some USS designs can further remove pollution through adsorption.

### Water Quality Considerations

- USS are not exposed to sunlight and diel cycles of temperature and DO.
- Stratification can produce low DO due to OM accumulation and decomposition.
- Decreased temperatures between inflow and outflow.

- Sedimentation can reduce infiltration and water quality performance.
- Few water quality studies are available for USS. Estimating water quality benefits should be made conservatively.

### Performance

- Effective removal of nutrients at median concentrations, less effective at low concentrations.
- High removal of suspended solids.

### UNDERGROUND STORAGE (INFILTRATION BASIN) MONITORING RESULTS FROM 2016 SUMMARY STATISTICS (ISW DATABASE QUERY – AUGUST 2019)

	E. COLI (CFU/100 ML)	TOTAL PHOSPHORUS (MG/L)	TOTAL NITROGEN (MG/L)	TOTAL SUSPENDED SOLIDS (MG/L)
Inflow*	0	0.471 (0.281-0.906, n=3)	2.28 (1.2-2.4, n=2)	38.5 (20-92.7, n=3)
Outflow*	0	0.38 (0.275-1.05, n=3)	1.2 (1.05-1.65, n=2)	20.1 (6.01-49, n=3)

\*Inflow and Outflow are median values (interquartile range, sample size).

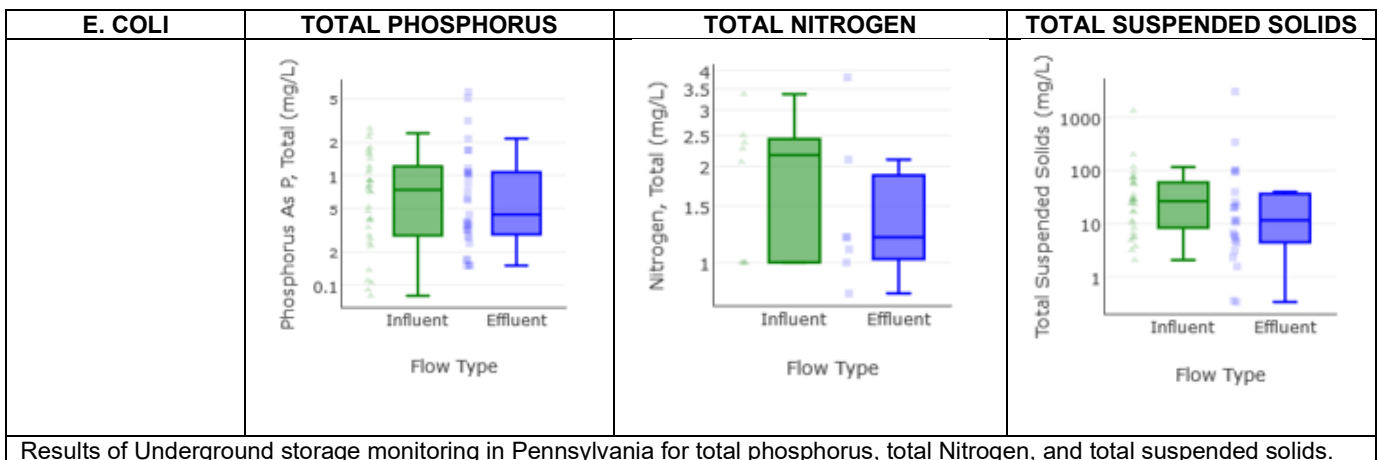

Results of Underground storage monitoring in Pennsylvania for total phosphorus, total Nitrogen, and total suspended solids.

# VEGETATED STRIPS

Filter strips are vegetated surfaces that are designed to treat sheet flow from adjacent surfaces. Filter strips function by slowing runoff velocities and allowing sediment and other pollutants to settle and by providing some infiltration into underlying soils. Filter strips are most effective when runoff passes over the filter surface as shallow, uniform sheet flow. They can suffer erosion and lack of treatment if exposed to concentrated flows. They are well suited to treat runoff from adjacent roads or small parking areas and are good for use as vegetated buffers between developed areas and natural drainages.

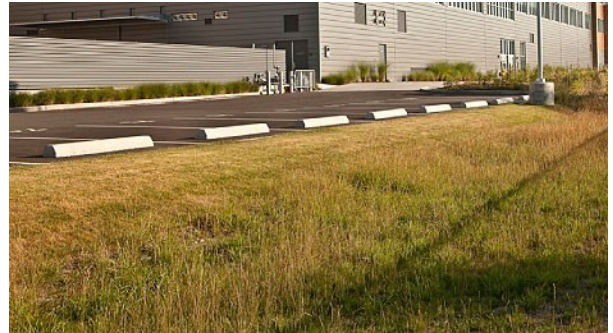

Filter strips can be as simple as a gentle slope covered in grass that receives runoff from an adjacent strip of parking stalls.

## Retrofit Opportunities



### Benefits

- Low construction cost and minimal maintenance requirements (erosion prevention)
- Can provide reliable water quality benefits if properly designed, vegetated, and maintained
- Good for roadside shoulders and landscape buffers when slope and length criteria are met
- Simple, aesthetically pleasing landscape features
- Easy to customize to varying site conditions

### Potential Constraints

- Not appropriate for industrial sites or locations where spills may occur
- Limited ability to treat large drainage areas
- Water quality benefits severely limited without adequate filter length and flow characteristics
- Does not provide significant stormwater volume reduction
- Only minor reduction in flow rate, especially during larger storms
- May require seasonal irrigation
- Needs reduced salt and sand application during winter months

### Siting Applications

- Roads and highway shoulders
- Small parking lots
- Residential, commercial, or institutional landscaping
- Pre-treatment component for subsequent BMP

## Technical Information

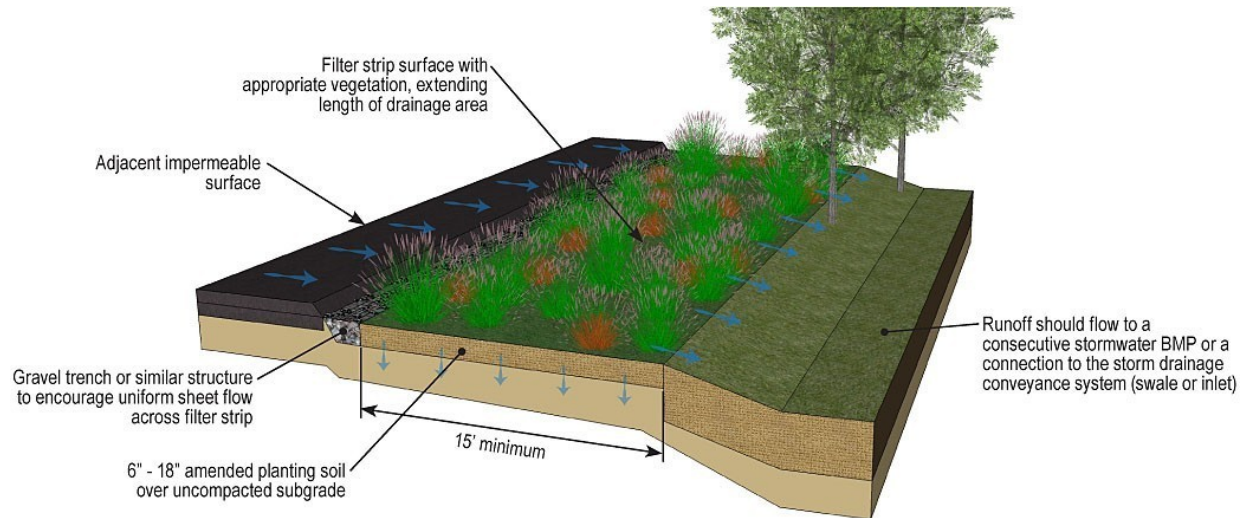

Figure: Filter strip typical detail

### Design & Sizing Criteria

- Filter strips are flow-based systems designed to convey the water quality flow across the vegetated surface at a flow velocity not exceeding 1 foot per second and maximum water depth not exceeding 1 inch.
- Should be at least 15 feet wide and preferably 25 feet wide (in the direction of flow) to provide adequate water quality treatment.
- Filter strips are considered effective at treating contributing impervious surface widths up to twice the width of the vegetated strip. The maximum length (in the direction of flow towards the filter strip) of the contributing tributary area should be 60 feet.
- Should be immediately adjacent to, and extend the full length of, the contributing drainage area.
- Ideal cross-slope is between 2% and 6% to avoid ponding (at low slopes) and concentrated flows (at high slopes). Slopes up to 15% may be acceptable with proper design and careful maintenance but are generally not recommended.
- If the cross-slope is less than 0.50%, or if the underlying soil infiltration rate is less than 0.5 in/hr., consider an underdrain system to facilitate drainage.
- Requires shallow, evenly-distributed sheet flow across the entire width of the strip. Level slopes perpendicular to the direction of flow are required to achieve sheet flow.
- A level spreading feature such as a gravel trench may help promote sheet flow, however if used it must be carefully maintained.

### Pollutant Removal

- Removes sediment and other suspended particles from runoff.
- Dissolved nutrients are removed from runoff through infiltration, plant uptake and adsorption to soil particles.
- Promotes degradation and transformation of pollutants.

### Water quality considerations

- Use to pretreat runoff and remove large material before sending to other GI for more improvements to water quality.
- Surface runoff must stay in sheet flow to receive proper water quality treatment.
- Use for snow storage in winter months. Be aware of salinity impacts.
- Similar to other GI with vegetation, a dense cover of plants that thrive in Utah will result in maximum performance.

### Performance

- The 2016 summary statistics show effective treatment for total nitrogen and total suspended solids.
- No monitor sites available in Colorado.
- Monitoring near Austin, Texas shows positive results for removing total phosphorus and total suspended solids from stormwater.

### VEGETATED STRIPS MONITORING RESULTS FROM 2016 SUMMARY STATISTICS (WERF 2017)

	E. COLI (CFU/100 ML)	TOTAL PHOSPHORUS (MG/L)	TOTAL NITROGEN (MG/L)	TOTAL SUSPENDED SOLIDS (MG/L)
Inflow*	-	0.14 (0.08-0.25, n=19)	1.4 (0.8-2.04, n=8)	44 (20-90, n=19)
Outflow*	-	0.17 (0.1-0.34, n=19)	1.13 (0.8-1.55, n=8)	19 (10-35, n=19)

\*Inflow and Outflow are median values (interquartile range, sample size).

E. COLI	TOTAL PHOSPHORUS	TOTAL NITROGEN	TOTAL SUSPENDED SOLIDS
No data.			
Results of vegetated strip monitoring near Austin, Texas for E. coli, total phosphorus, total nitrogen, and total suspended solids.			



# VEGETATED BASIN

Vegetated basins are temporary holding areas for stormwater that capture and detain flows from a design storm for some minimum time (e.g. 48 hours) to allow suspended solids and associated pollutants to settle. They are typically designed with an outlet structure that slowly releases the water requiring treatment via a small orifice and allows controlled routing of larger events. Water quality drawdown can be achieved through infiltration, if site conditions will allow. Stormwater collected in vegetated basins can be re-used for landscape irrigation, and basins can also be used to provide flood control by including additional flood detention storage.



Basins that are thoughtfully designed and planted can manage stormwater from a larger area, while still offering aesthetic appeal.

## Retrofit Opportunities



### Benefits

- Relatively low construction and maintenance costs
- Highly effective at attenuating peak flows, can reduce runoff volumes with infiltration or reuse
- Improves water quality by removing particulate matter, sediment, trash, and debris
- Suitable for sites where infiltration is poor or not an option
- Suitable for large drainage areas
- Multi-purpose detention ponds can provide open space, habitat, and aesthetic amenity

### Potential Constraints

- Limitations of the release orifice may not allow use of detention in watersheds of less than 5 acres (would require an orifice with a diameter of less than 0.5 inches that would be prone to clogging)
- Only moderate pollutant removal compared to some other BMPs and ineffective at removing soluble pollutants
- May exhibit undesirable aesthetics due to dry, bare areas and inlet and outlet structures
- Site must have no risk of land slippage if soils are saturated

### Siting Applications

- Parks, open spaces, and golf courses
- Commercial, industrial, or residential developments
- Regional detention & treatment

### Design Variation

A basin designed with a permanent pool is commonly referred to as a wet pond; additional treatment and amenity benefits can be realized by the body of water, along with maintenance and the need for base flow or supplemental water.

## Technical Information

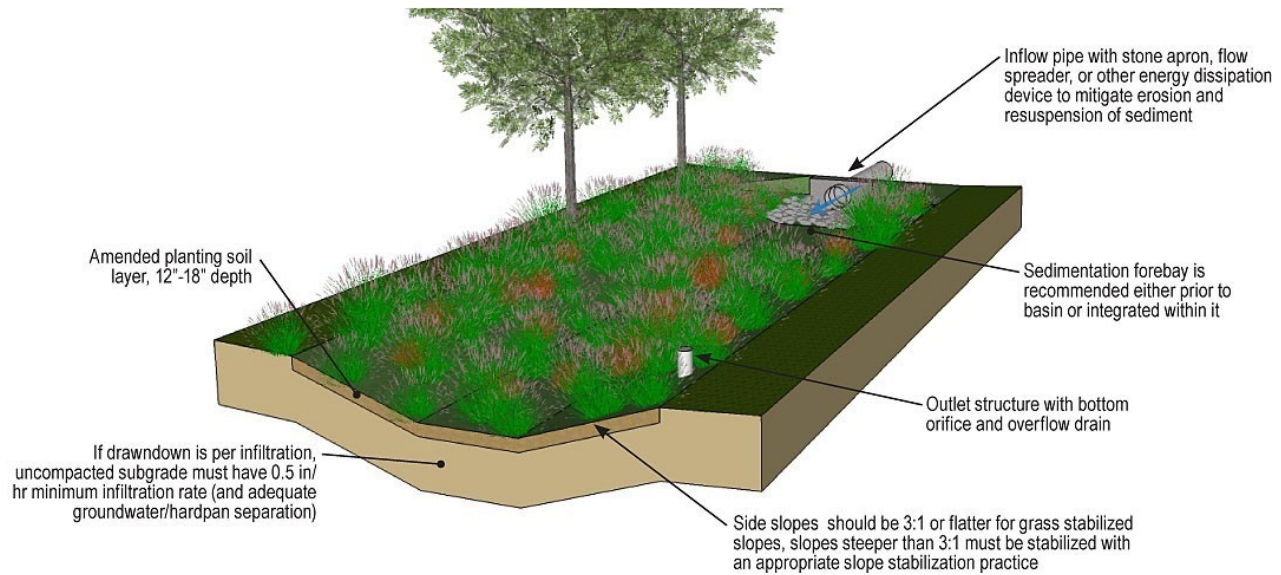

Figure: Vegetated basin typical detail

## Design & Sizing Criteria

- Vegetated basins are volume-based systems sized to capture the water quality volume and discharge it within a typical 48-hour drawdown time, with no more than 50% of the total volume draining in the first 16 hours.
- Longer drawdown times may result in vector breeding and should be used only after coordination with local vector control authorities. Shorter times should be limited to BMP drainage areas with coarse soils that readily settle or where infiltration is responsible for the majority of drawdown.
- A length to width ratio of at least 1.5:1 (and ideally 3:1) is recommended for greatest treatment capability (due to a longer flow path).
- A reinforced channel from inlet to outlet can be included to convey low flows through the basin.
- Maintenance can be reduced if runoff passes through upstream filtration BMPs or a sedimentation forebay prior to entering the basin.
- Outlet structure(s) include an orifice (and/or infiltration) for drawdown, an overflow drain for storms greater than the design storm, and an emergency spillway/drain for large flood events.
- If the separation from the bottom of the facility to the seasonally high groundwater elevation is less than 10 feet, the facility should be lined with impermeable liner (compacted native clay or geomembrane).
- If sufficient space is available, a vegetated buffer around the pond can be used to slow overland runoff entering via the side slopes, help prevent access to the pond if desired, and provide an aesthetic and habitat amenity.

### Pollutant removal

- Remove pollution through settling and possibly infiltration if site conditions allow.
- Not very effective at removing dissolved pollution. Vegetation uptake can occur but minimal.

- Can remove coarse suspended material (e.g. branches, trash, etc.) due to restricted outflow.
- Can reduce downstream erosion by reducing magnitude and timing of peak flow

### Water Quality Considerations

- Need regular maintenance to keep outlet clear and ensure proper function.
- Dead vegetation in basin should be disposed of to reduce OM loading to downstream waters.

- Remove all clippings from basin if vegetation is mowed.

### Performance

- Effective removal for all pollutants except for nitrogen. Positive results for nitrogen at monitored sites in Texas.
- High removal for E. coli at low concentrations, and TSS for all concentrations.

## VEGETATION BASIN (DETENTION BASIN) MONITORING RESULTS FROM 2016 SUMMARY STATISTICS (WERF 2017)

	E. COLI (CFU/100 ML)	TOTAL PHOSPHORUS (MG/L)	TOTAL NITROGEN (MG/L)	TOTAL SUSPENDED SOLIDS (MG/L)
Inflow*	0	0.23 (0.14-0.38, n=31)	1.15 (0.79-1.7, n=15)	68 (24.1-129, n=32)
Outflow*	0	0.19 (0.11-0.3, n=31)	1.19 (0.74-2.1, n=15)	24.3 (10.5-49.6, n=33)

\*Inflow and Outflow are median values (interquartile range, sample size).

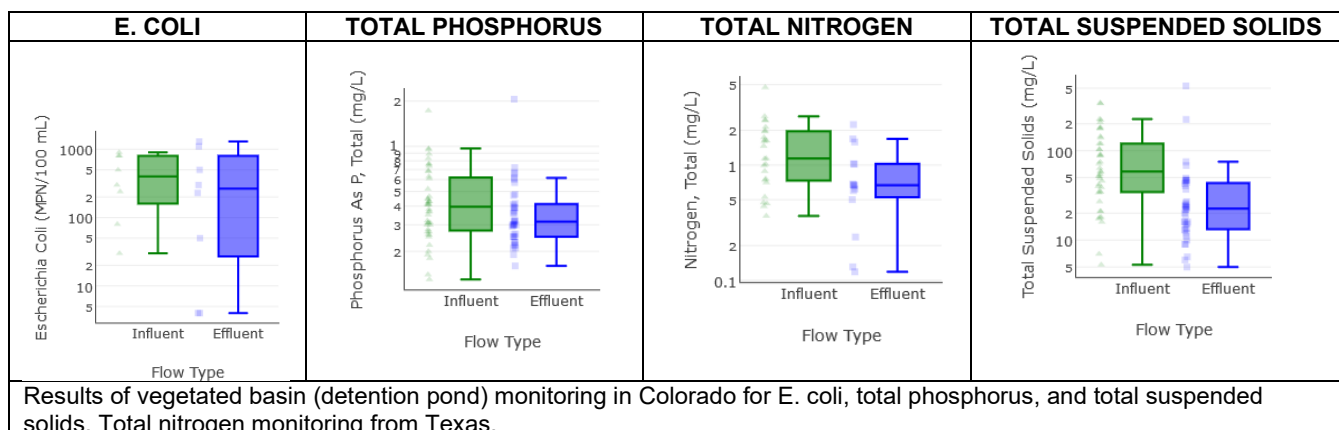



# GREEN ROOF

A green roof is a vegetated system covering a building's roof that detains and filters direct rainfall. Stormwater is captured in the soil media and storage layers of the system, reducing peak storm flows and promoting evapotranspiration. A primary water quality benefit of green roofs is that they avoid the common pollutants associated with conventional roof runoff, instead releasing only rainwater that has been further filtered. Green roofs can be designed with minimal thickness to allow retrofit installation on existing buildings or with a mix of shrubs, trees, pathways, and benches to be a valuable amenity for building tenants and the public.



Green roofs are unique stormwater features which also provide a variety of diverse benefits to building systems as well as inhabitants and users.

## Application Examples



*Extensive green roof*



*Intensive green roof*

## Benefits

- Reduces the peak discharge rate by slowing down roof runoff
- Enhances site aesthetics and can provide a useable amenity or public space
- Creates habitat and increases vegetation, even in densely developed areas
- Can extend the life of the roof, compared to a conventional roof
- Reduces heat island effect and improves air quality
- Provides insulation, which reduces building energy use

## Potential Constraints

- Not ideal for steep roofs (>20 degrees)
- Only manages rooftop runoff
- Greater roof weight may increase dead and live loads and increase structural support requirements
- Existing buildings may not be able to support increased load
- Will likely require irrigation during establishment (typically first 2 years) and dry seasons
- Requires increased maintenance compared to a conventional roof
- Higher cost than other GI technologies

## Siting Applications

- Commercial, industrial, and large residential buildings
- Public spaces like libraries and museums
- Urban areas with limited space and/or minimal vegetation



## Technical Information

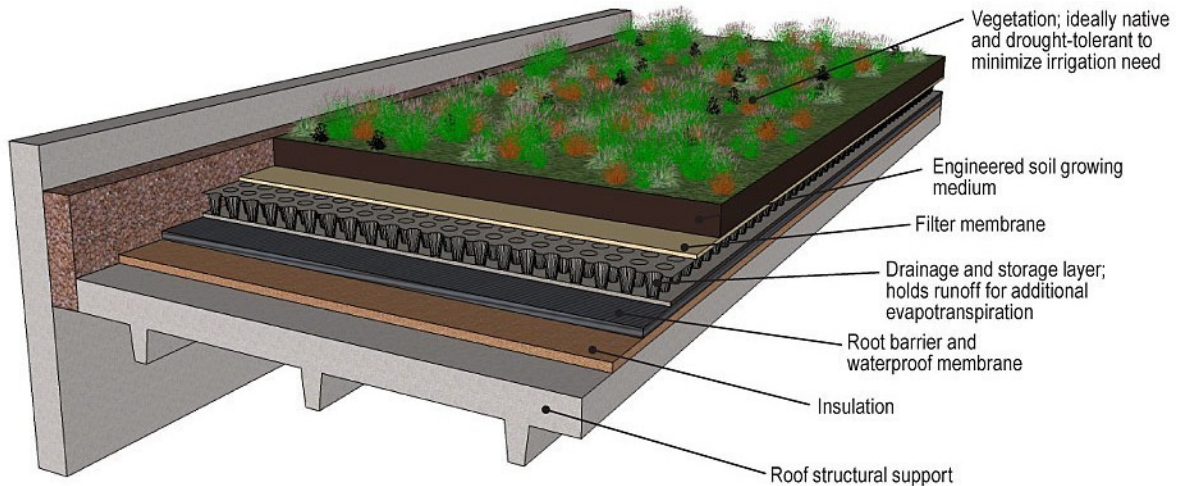

Figure: Green roof typical detail

### Design & Sizing Criteria

- Green roofs are flow-based systems designed to treat the rainfall that falls directly onto the vegetated area.
- Runoff from rooftop areas that are not part of the vegetated system (such as spaces for mechanical or ventilation equipment) will likely need to be routed to treatment areas on the ground.
- Green roofs are generally classified as either extensive or intensive. Extensive green roofs generally have six inches or less of soil media, use smaller plants, are lower maintenance, and are typically not intended to be accessible. Intensive green roofs have greater than six inches of soil, larger plants, greater structural and maintenance requirements, and are often designed as rooftop gardens or park-like settings for use by people.
- They are most suitable for flat roofs or those with slopes less than 20 degrees. Extensive green roofs can be constructed on slopes up to 40 degrees with specialized designs.
- A new or retrofit building must be designed to support the weight of the green roof when all layers and vegetation are fully saturated. This wet weight can be up to 6 or 7 pounds per square foot per inch of soil depth.
- A waterproof membrane is needed to protect the roof structure and a root barrier can be installed to protect the membrane. Insulation, if included, can be installed either above or below the waterproof membrane.

### Pollutant removal

- Remove suspended solids by infiltration and adsorption to porous media, nutrient uptake by plants.
- Plant cover intercepts rain and solar radiation.
- Vegetation traps particulates from roof (dirt, bird droppings, etc.).
- Evapotranspiration adds moisture.

### Water quality considerations

- Water retention can vary, depending on roof configuration.
- Green roof can act as a source of pollutants in dry climates.
- Outflow from roof is suitable for non-potable uses such as landscape irrigation.

### Performance

- No influent data for total phosphorus and total suspended solids.
- Effective removal for E. Coli in Oregon.

#### GREEN ROOF MONITORING RESULTS FROM 2016 SUMMARY STATISTICS (ISW DATABASE QUERY AUGUST 2019)

	E. COLI (CFU/100 ML)	TOTAL PHOSPHORUS (MG/L)	TOTAL NITROGEN (MG/L)	TOTAL SUSPENDED SOLIDS (MG/L)
Inflow*	291 (27.8-1260, n=5)	0.057 (0.0378-0.1, n=10)	0.0453 (0.02-0.081, n=3)	5.02 (2-12.3, n=9)
Outflow*	52 (11.5-185, n=5)	0.435 (0.32-0.847, n=10)	1.87 (1.27-3.25, n=3)	5 (3-10, n=9)

\*Inflow and Outflow are median values (interquartile range, sample size).

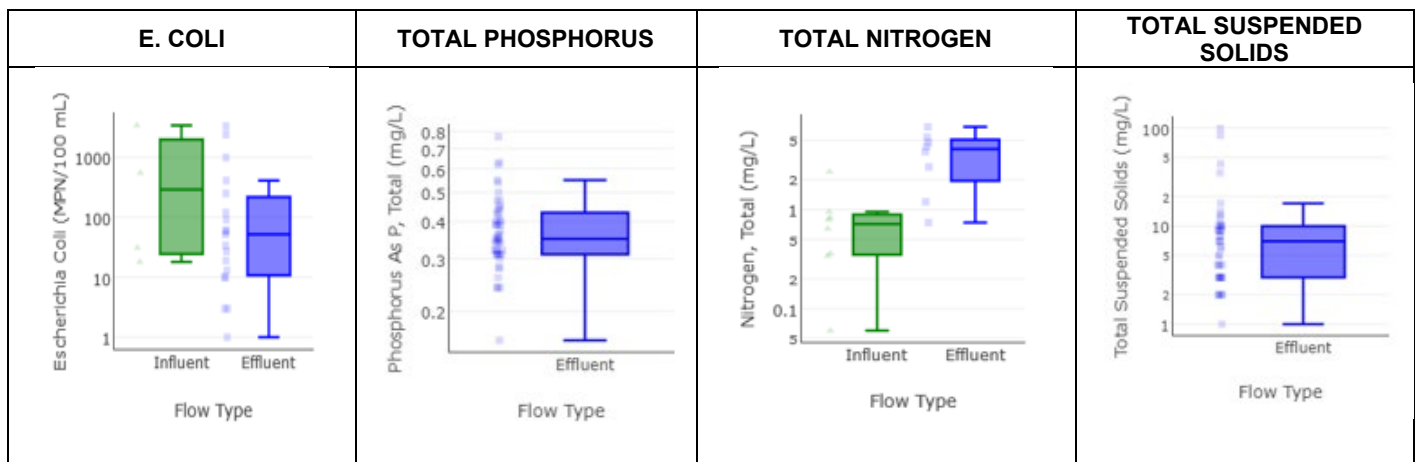

Results of green roof monitoring in Colorado for total phosphorus, and total suspended solids. Total nitrogen monitoring from North Carolina. E.coli monitoring from Oregon.

*For 90 degree intersects (L-shaped), use two 60'x 20' sight triangles measured along Top Back of Curb*

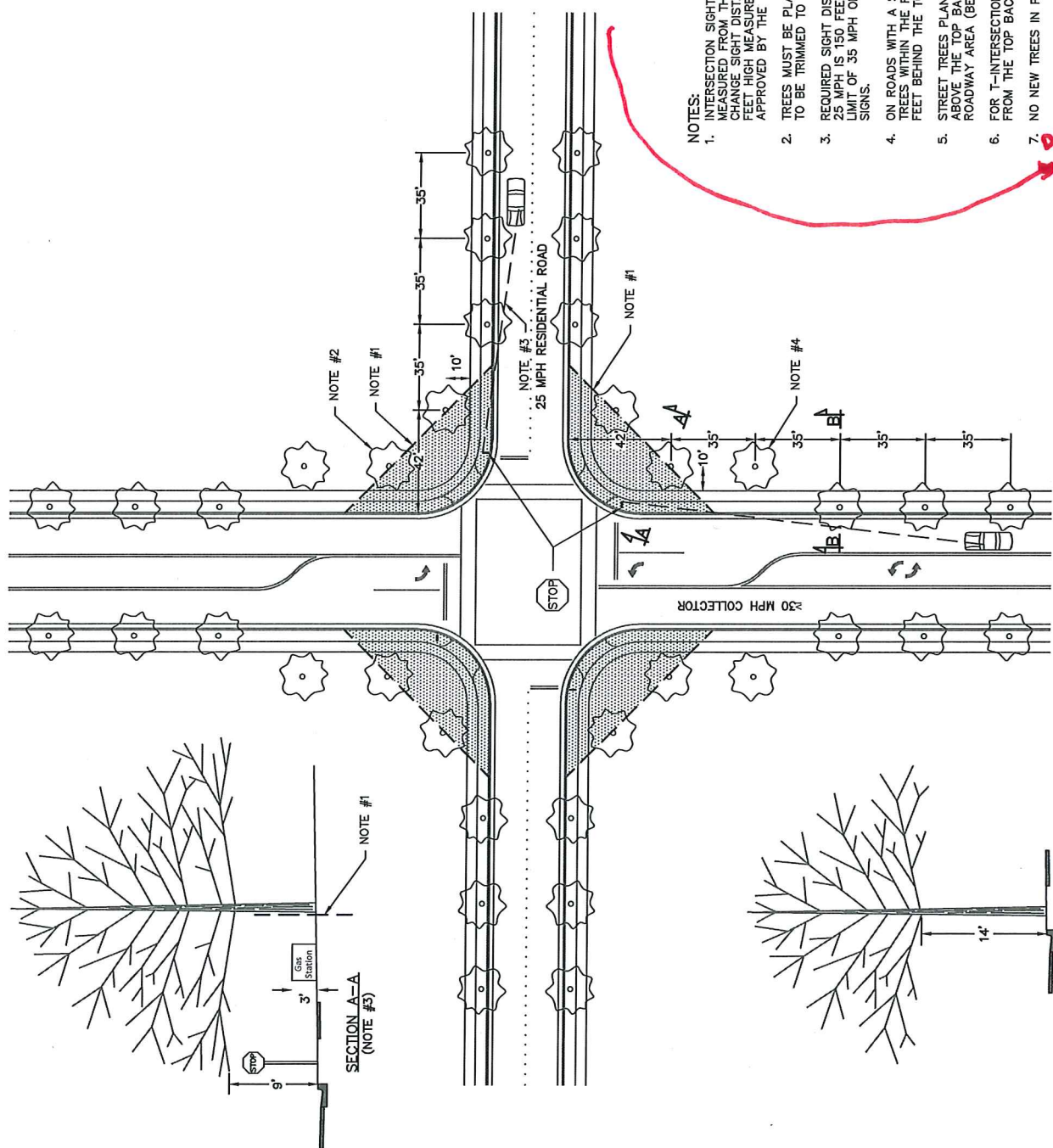

- NOTES:**
- INTERSECTION SIGHT TRIANGLES ARE TYPICALLY 60 FEET BY 60 FEET MEASURED FROM THE TOP BACK OF CURB. INTERSECTION GEOMETRY WILL CHANGE SIGHT DISTANCE REQUIREMENTS. NO IMPROVEMENTS ALLOWED OVER 3 FEET HIGH MEASURED FROM THE TOP BACK OF CURB (UNLESS OTHERWISE APPROVED BY THE CITY TRANSPORTATION ENGINEER).
  - TREES MUST BE PLANTED OUTSIDE OF THE SIGHT TRIANGLE. BRANCHES NEED TO BE TRIMMED TO EIGHT (8) FEET ABOVE THE TOP BACK OF CURB.
  - REQUIRED SIGHT DISTANCE TO STOP SIGNS ON ROADS WITH A SPEED LIMIT OF 25 MPH IS 150 FEET. SPEED LIMITS OF 30 MPH IS 200 FEET, AND SPEED LIMIT OF 35 MPH OR MORE IS 250 FEET OF CLEAR SIGHT DISTANCE TO STOP SIGNS.
  - ON ROADS WITH A SPEED LIMIT OR 30 MPH OR MORE REQUIRES THAT STREET TREES WITHIN THE FIRST 100 FEET OF THE INTERSECTION BE PLANTED TEN (10) FEET BEHIND THE TOP BACK OF THE SIDEWALK.
  - STREET TREES PLANTED WITHIN THE PARKSTRIP SHALL BE TRIMMED TO 14 FEET ABOVE THE TOP BACK OF CURB WHEN THE CANOPY CROSSES INTO THE ROADWAY AREA (BEYOND THE TOP BACK OF CURB).
  - FOR T-INTERSECTIONS USE A 60 FEET BY 20 FEET SIGHT TRIANGLE MEASURED FROM THE TOP BACK OF CURB (60 FEET BEING ON THE THROUGH STREET).
  - NO NEW TREES IN PARKSTRIPS LESS THAN 8' WIDE.



STANDARD DETAIL  
PUBLIC WORKS  
**TS-04**  
INTERSECTION SIGHT DISTANCE

1	R. KUMP	DWG REVISION	5/24/17
NO.	AUTHORIZED BY	REVISIONS	DATE

SECTION B-B  
(NOTE #5)

SECTION A-A  
(NOTE #3)

# HAMMERHEAD TURNAROUND

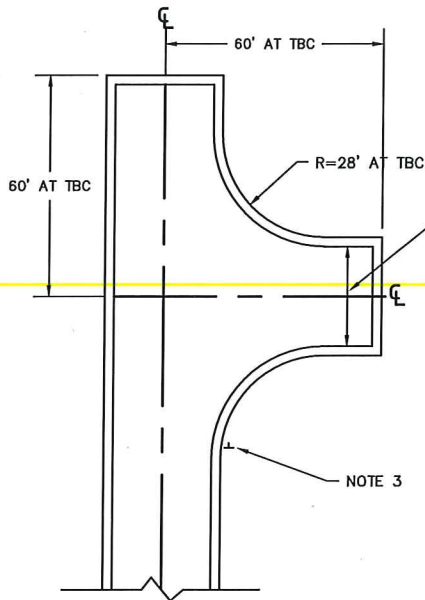

ALTERNATE 1

EQUAL OR GREATER THAN 20' AT LIP OF GUTTER OR AS REQUIRED BY THE CITY ENGINEER

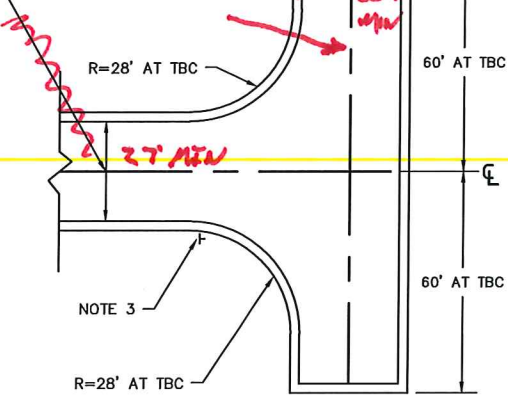

ALTERNATE 2

## CUL-DE-SAC

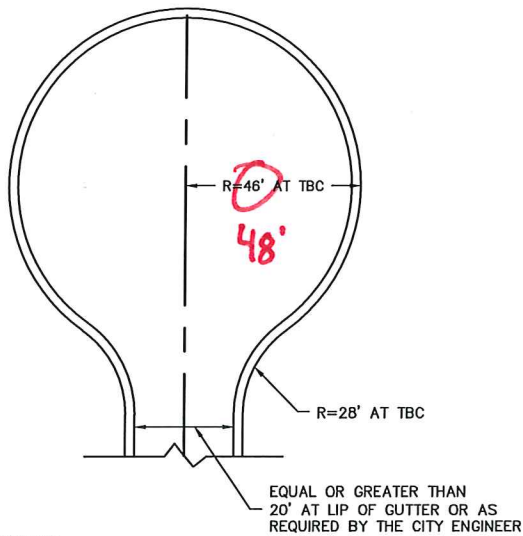

### GENERAL NOTES:

1. THE USE OF THE HAMMERHEAD TURNAROUND WILL BE LIMITED TO CERTAIN APPLICATIONS AND WILL REQUIRE APPROVAL OF THE CITY ENGINEER.
2. THE MAXIMUM LENGTH OF A STREET WITH A HAMMERHEAD TURNAROUND SHALL BE 150 FEET TO THE END OF THE TURNAROUND.
3. "NO PARKING" SIGNS ~~ARE~~ REQUIRED AS SHOWN. **AS DIRECTED BY CITY ENGINEER**
4. FIRE HYDRANTS SHALL NOT BE LOCATED WITHIN PRIVATE STREETS HAVING A HAMMERHEAD TURNAROUND, UNLESS SPECIFICALLY APPROVED BY THE CITY ENGINEER.
5. DESIGNS SHOWN ARE TYPICAL MINIMUM DESIGNS. FINAL DESIGNS SHALL MEET THE APPROVAL OF THE CITY ENGINEER.
6. PAVEMENT SECTION SHALL CONFORM WITH CITY SPECIFICATION.
7. SIDEWALK, PARKSTRIPS AND ADA RAMPS SHALL BE ADDED AS REQUIRED BY THE CITY AND CONFORM WITH CITY SPECIFICATIONS.
8. ALTERNATE 1 MAY ALSO BE MIRRORED TO THE LEFT.

## KNUCKLE

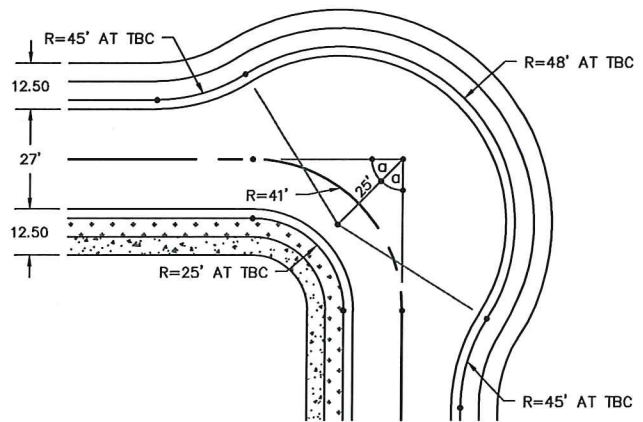

### KNUCKLE NOTES:

1. THE USE OF THE KNUCKLE WILL BE LIMITED TO CERTAIN APPLICATIONS AND WILL REQUIRE APPROVAL OF THE CITY ENGINEER.
2. THIS DRAWING REPRESENTS A 90° DEFLECTION ON A RESIDENTIAL STREET. IT IS FOR USE ON STREETS WITH A DEFLECTION FROM 80° TO 100°.
3.  $\alpha = 1/2$  DEFLECTION ANGLE

1	R. KUMP	DWG REVISION	5/24/17
2	R. KUMP	KNUCKLE ADD.	1/1/21
NO.	AUTHORIZED BY	REVISIONS	DATE



STANDARD DETAIL  
PUBLIC WORKS  
**TS-05**  
HAMMERHEAD TURNAROUND  
CUL-DE-SAC, AND KNUCKLE



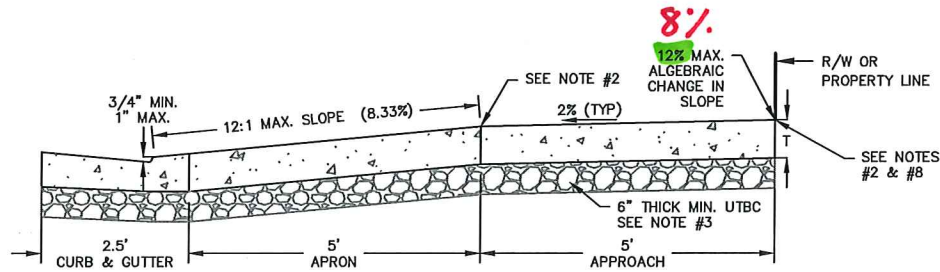
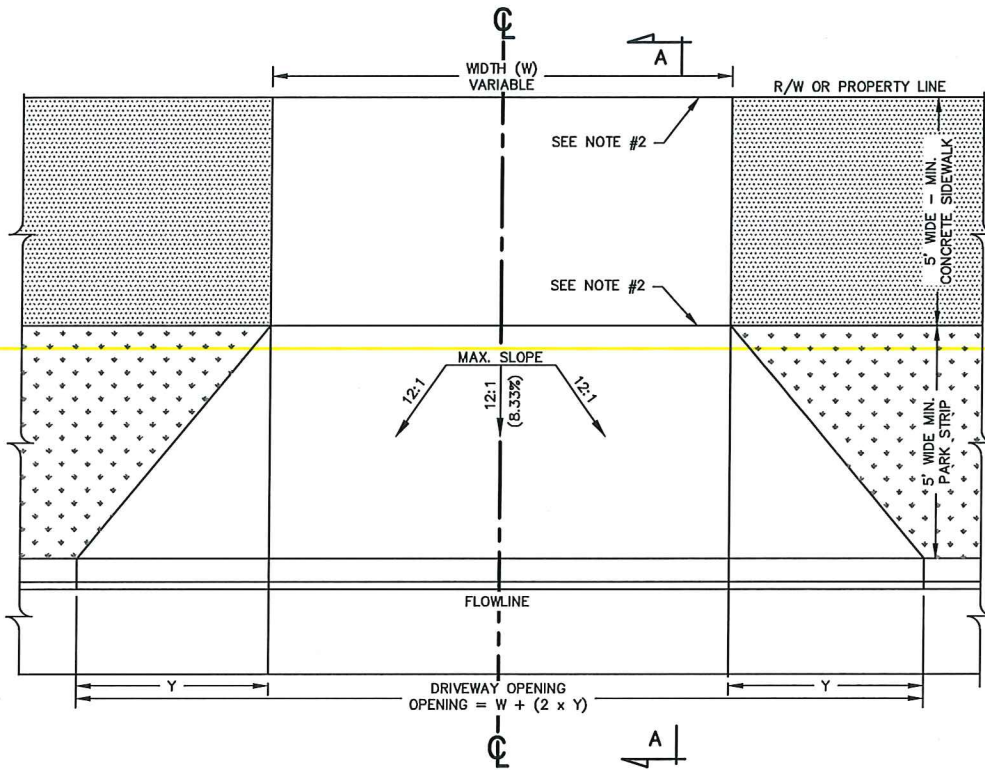

SECTION A-A

GENERAL NOTES

- EDGE CONCRETE WITH 1/2" RADIUS EDGING TOOL.
- PLACE 1/2" AC IMPREGNATED EXPANSION JOINT WHERE NOTED AND IN THE DRIVEWAY CENTERLINE IF "W" IS GREATER THAN 20'. EXPANSION JOINT SHALL BE FULL DEPTH OF CONCRETE PLUS 1", WITH TOP SET FLUSH WITH TOP OF CONCRETE.
- USE 6" MIN. UNTREATED BASE COURSE MATERIAL. COMPACT TO 96% OF MAXIMUM DRY DENSITY.
- SEE "SW-03 CONCRETE SIDEWALK" FOR SIDEWALK JOINT PATTERN.
- THE MAXIMUM GRADE AT WHICH DRIVEWAYS WILL BE ALLOWED TO BE BUILT IS **12%** SLOPE, UNLESS PERMITTED BY ENGINEER. THE MINIMUM GRADE ALLOWED IS 2% SLOPE.
- CONCRETE SHALL COMPLY WITH SANDY CITY STANDARD SPECIFICATION SECTION 03000.
- ALL CONCRETE SLABS WITH A LENGTH/WIDTH RATIO GREATER THAN 2:1 SHALL HAVE CONTRACTION JOINTS INSTALLED AS REQUIRED TO MAINTAIN A 2:1 RATIO MAX.
- ALL DRIVEWAYS MUST MAINTAIN A NEGATIVE SLOPE AWAY FROM THE HOME. NO DOWN SLOPING DRIVEWAYS WILL BE ALLOWED UNLESS APPROVED BY ENGINEER.
- CITY ENGINEER APPROVAL IS REQUIRED FOR COMMERCIAL USE.

TABLE OF DRIVEWAY DIMENSIONS	
DIMENSION	ZONE
Y	5' OR 12:1 SLOPE, WHICH EVER DISTANCE IS GREATER
T	0'-6" RESIDENTIAL ZONES 0'-7" COMMERCIAL & INDUSTRIAL ZONES
W	24'-0" MIN. INDUSTRIAL & COMMERCIAL USE 16'-0" MIN. MAJOR & COLLECTOR STREET RESIDENTIAL USE 12'-0" MIN. LOCAL STREET RESIDENTIAL USE 36'-0" MAX. ALL DRIVEWAYS

1	R. KUMP	DWG REVISION	5/24/17
NO.	AUTHORIZED BY	REVISIONS	DATE

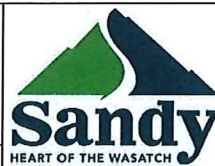

STANDARD DETAIL  
PUBLIC WORKS  
**DA-01**  
FLARED DRIVE APPROACH  
(RESIDENTIAL)

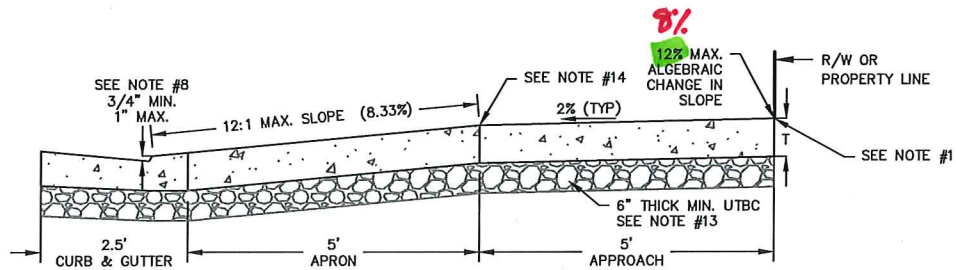
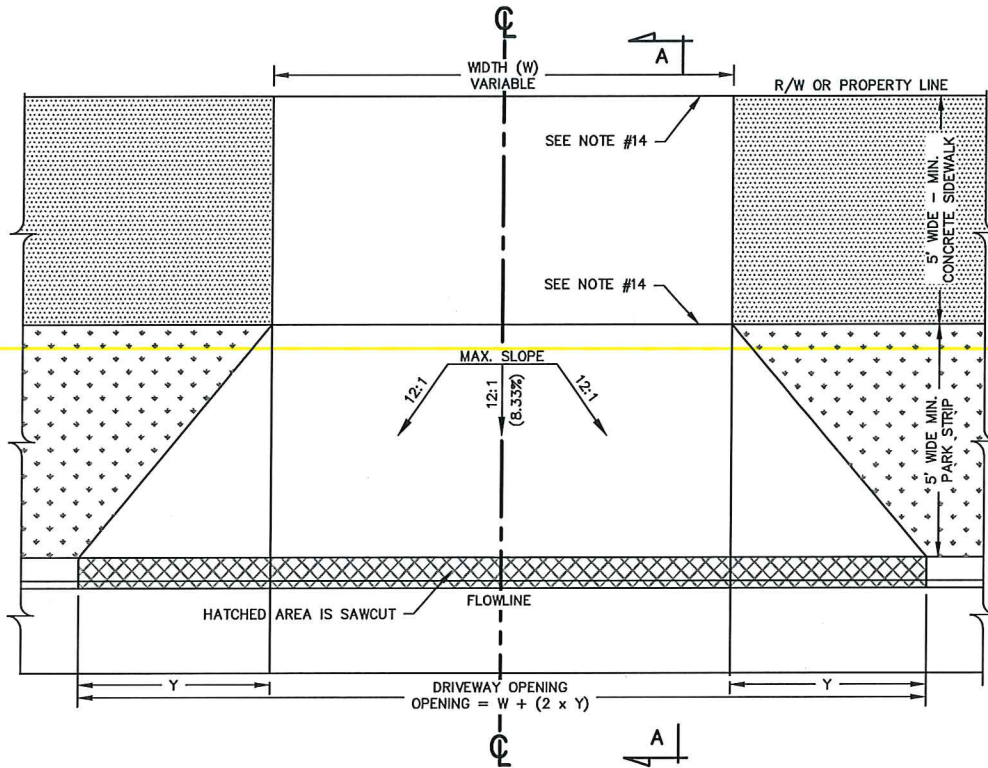

SECTION A-A

TABLE OF DRIVEWAY DIMENSIONS	
DIMENSION	ZONE
Y	5' OR 12:1 SLOPE, WHICH EVER DISTANCE IS GREATER
T	0'-6" RESIDENTIAL ZONES 0'-7" COMMERCIAL & INDUSTRIAL ZONES
W	24'-0" MIN. INDUSTRIAL & COMMERCIAL USE 16'-0" MIN. MAJOR & COLLECTOR STREET RESIDENTIAL USE 12'-0" MIN. LOCAL STREET RESIDENTIAL USE 36'-0" MAX. ALL DRIVEWAYS

GENERAL NOTES

1. THE MAXIMUM GRADE AT WHICH DRIVEWAYS WILL BE ALLOWED TO BE BUILT IS **12%** SLOPE, UNLESS PERMITTED BY ENGINEER. THE MINIMUM GRADE ALLOWED IS 2% SLOPE.
2. EDGE CONCRETE WITH 1/2" RADIUS EDGING TOOL.
3. HORIZONTAL CUT TO BE WIDTH OF DRIVEWAY PLUS THE "Y" DIMENSION AND THE FLARES ON EACH SIDE.
4. SAWCUT MUST BE SLOPED TOWARD THE GUTTER TO MATCH SLOPE OF APRON.
5. SIDEWALK SECTION MUST BE 6" MINIMUM THICKNESS THROUGH WIDTH OF DRIVEWAY OR BE REPLACED WITH 6" CONCRETE TO NEAREST JOINT BEYOND WIDTH OF DRIVEWAY.
6. NO OVERCUTTING WHERE CUTS MERGE.
7. PATCH ALL HOLES 1/2" OR LARGER IN EXPOSED SURFACE WITH UDOT APPROVED PATCHING COMPOUND.
8. GRIND FRONT EDGES TO AN APPROXIMATE 1-1/2" RADIUS.
9. GRIND SAWED SURFACE SO THAT NO BLADE MARKS APPEAR.
10. REMOVE AND REPLACE ALL DETERIORATED, WEAK OR UNSOUND CONCRETE.
11. ALL DRIVEWAYS MUST MAINTAIN A NEGATIVE SLOPE AWAY FROM THE HOME. NO DOWN SLOPING DRIVEWAYS WILL BE ALLOWED UNLESS APPROVED BY ENGINEER.
12. CONCRETE SHALL COMPLY WITH SANDY CITY STANDARD SPECIFICATION SECTION 03000.
13. USE 6" MIN. UNTREATED BASE COURSE MATERIAL. COMPACT TO 96% OF MAXIMUM DRY DENSITY.
14. PLACE 1/2" AC IMPREGNATED EXPANSION JOINT WHERE NOTED AND IN THE DRIVEWAY CENTERLINE IF "W" IS GREATER THAN 20'. EXPANSION JOINT SHALL BE FULL DEPTH OF CONCRETE PLUS 1", WITH TOP SET FLUSH WITH TOP OF CONCRETE.
15. SEE "SW-03 CONCRETE SIDEWALK" FOR SIDEWALK JOINT PATTERN.
16. CITY ENGINEER APPROVAL IS REQUIRED FOR COMMERCIAL USE.

1	R. KUMP	DWG REVISION	5/24/17
NO.	AUTHORIZED BY	REVISIONS	DATE

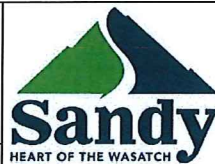

STANDARD DETAIL  
PUBLIC WORKS  
**DA-02**  
FLARED DRIVE APPROACH REQUIRING  
CURB CUT (RESIDENTIAL)

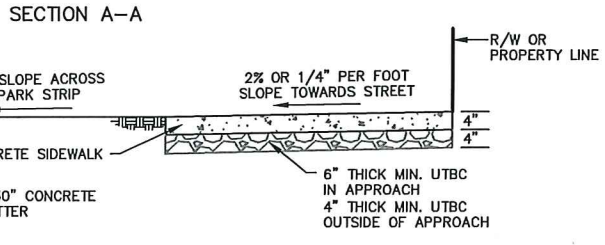
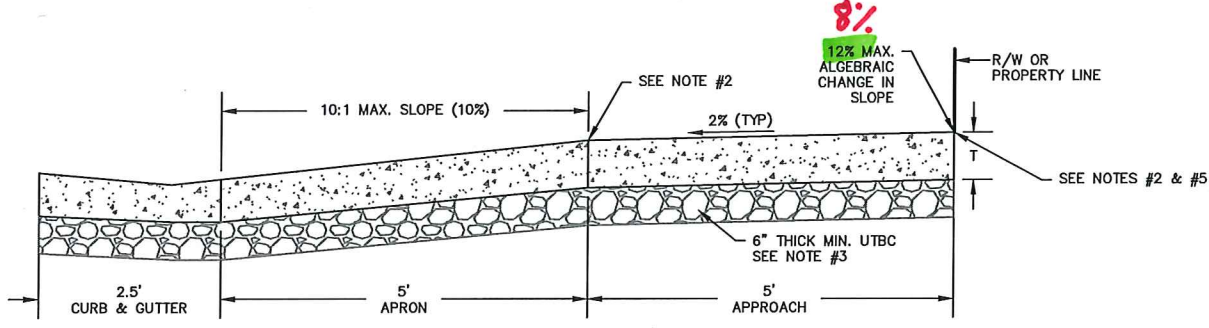
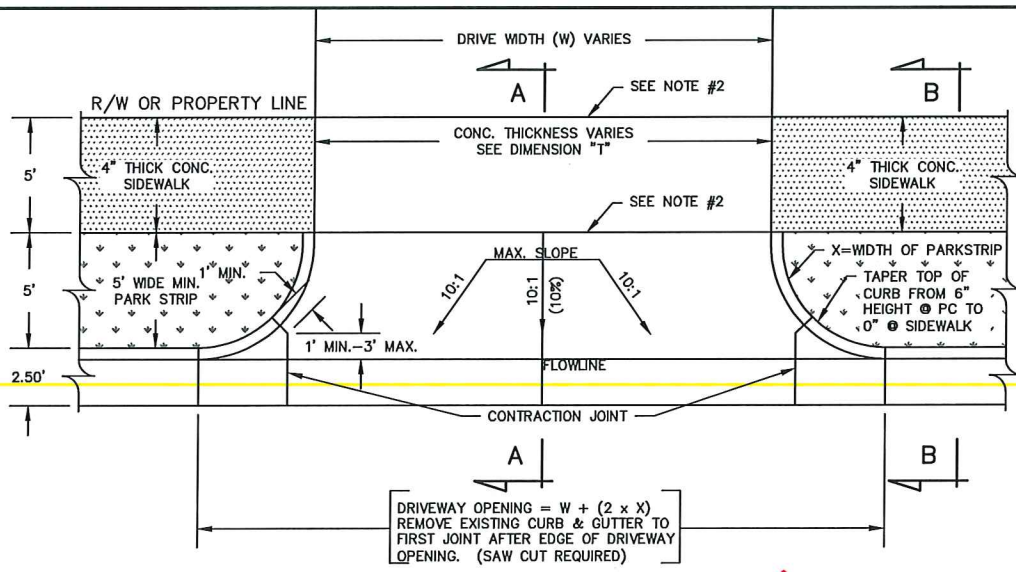

- GENERAL NOTES**
- EDGE CONCRETE WITH 1/2" RADIUS EDGING TOOL.
  - PLACE 1/2" AC IMPREGNATED EXPANSION JOINT BETWEEN THE APRON AND THE APPROACH, AND IN THE DRIVEWAY CENTERLINE IF "W" IS GREATER THAN 20'. EXPANSION JOINT SHALL BE FULL DEPTH OF CONCRETE PLUS 1" WITH TOP SET FLUSH WITH TOP OF CONCRETE.
  - USE 6" MIN. UNTREATED BASE COARSE MATERIAL. COMPACT TO 96% OF MAXIMUM DRY DENSITY.
  - SEE "SW-03 CONCRETE SIDEWALK" FOR JOINT PATTERN.
  - THE MAXIMUM GRADE AT WHICH DRIVEWAYS WILL BE ALLOWED TO BE BUILT IS 12% SLOPE, UNLESS PERMITTED BY ENGINEER. THE MINIMUM GRADE ALLOWED IS 2% SLOPE.
  - CONCRETE SHALL COMPLY WITH SANDY CITY STANDARD SPECIFICATION SECTION 03000.
  - ALL CONCRETE SLABS WITH A LENGTH TO WIDTH RATIO GREATER THAN 2:1 SHALL HAVE CONTRACTION JOINTS INSTALLED AS REQUIRED TO MAINTAIN A 2:1 MAX. RATIO.
  - DRIVEWAY MUST MAINTAIN A NEGATIVE SLOPE TOWARD APRON. NO DOWN SLOPING DRIVEWAYS WILL BE PERMITTED UNLESS APPROVED BY ENGINEER.
  - CITY ENGINEER APPROVAL IS REQUIRED FOR RESIDENTIAL USE.

DIMENSION	ZONE
T	0'-6" RESIDENTIAL ZONES 0'-7" COMMERCIAL & INDUSTRIAL ZONES
W	24'-0" MIN. INDUSTRIAL & COMMERCIAL USE 16'-0" MIN. MAJOR & COLLECTOR STREET RESIDENTIAL USE 12'-0" MIN. LOCAL STREET RESIDENTIAL USE 36'-0" MAX. ALL DRIVEWAYS

1	R. KUMP	DWG REVISION	5/24/17
NO.	AUTHORIZED BY	REVISIONS	DATE

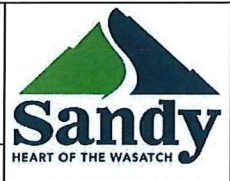

STANDARD DETAIL  
PUBLIC WORKS  
**DA-03**  
RADIUS DRIVE APPROACH  
(COMMERCIAL)



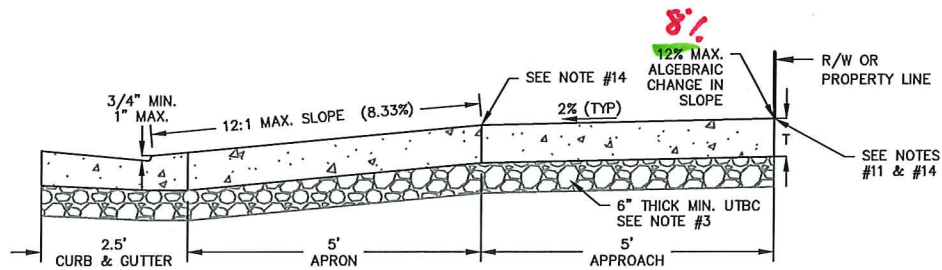
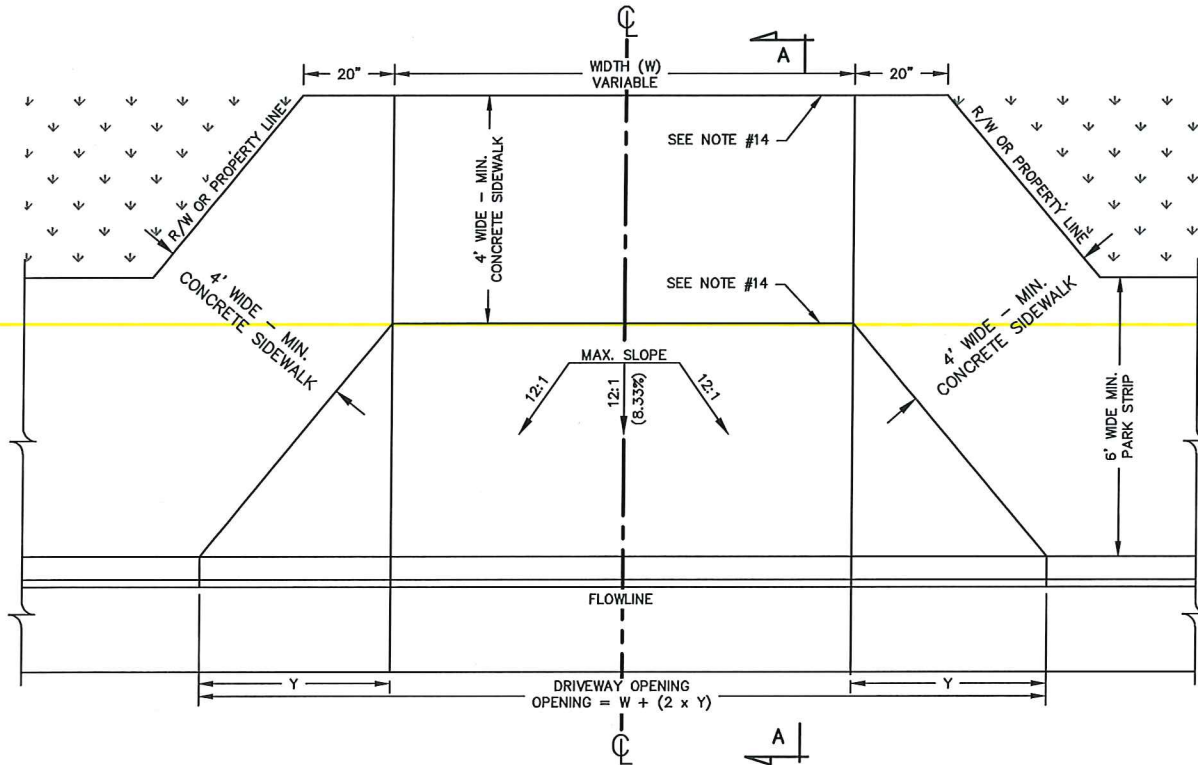

SECTION A-A

GENERAL NOTES

1. THE MAXIMUM GRADE AT WHICH DRIVEWAYS WILL BE ALLOWED TO BE BUILT IS **12% SLOPE**, UNLESS PERMITTED BY ENGINEER. THE MINIMUM GRADE ALLOWED IS 2% SLOPE.
2. EDGE CONCRETE WITH 1/2" RADIUS EDGING TOOL.
3. HORIZONTAL CUT TO BE WIDTH OF DRIVEWAY PLUS THE "Y" DIMENSION AND THE FLARES ON EACH SIDE.
4. SAWCUT MUST BE SLOPED TOWARD THE GUTTER TO MATCH SLOPE OF APRON.
5. SIDEWALK SECTION MUST BE 6" MINIMUM THICKNESS THROUGH WIDTH OF DRIVEWAY OR BE REPLACED WITH 6" CONCRETE TO NEAREST JOINT BEYOND WIDTH OF DRIVEWAY.
6. NO OVERCUTTING WHERE CUTS MERGE.
7. PATCH ALL HOLES 1/2" OR LARGER IN EXPOSED SURFACE WITH UDOT APPROVED PATCHING COMPOUND.
8. GRIND FRONT EDGES TO AN APPROXIMATE 1-1/2" RADIUS.
9. GRIND SAWED SURFACE SO THAT NO BLADE MARKS APPEAR.
10. REMOVE AND REPLACE ALL DETERIORATED, WEAK OR UNSOUND CONCRETE.
11. ALL DRIVEWAYS MUST MAINTAIN A NEGATIVE SLOPE AWAY FROM THE HOME. NO DOWN SLOPING DRIVEWAYS WILL BE ALLOWED UNLESS APPROVED BY ENGINEER.
12. CONCRETE SHALL COMPLY WITH SANDY CITY STANDARD SPECIFICATION SECTION 03000.
13. USE 6" MIN. UNTREATED BASE COURSE MATERIAL. COMPACT TO 96% OF MAXIMUM DRY DENSITY.
14. PLACE 1/2" AC IMPREGNATED EXPANSION JOINT WHERE NOTED AND IN THE DRIVEWAY CENTERLINE IF "W" IS GREATER THAN 20'. EXPANSION JOINT SHALL BE FULL DEPTH OF CONCRETE PLUS 1", WITH TOP SET FLUSH WITH TOP OF CONCRETE.
15. SEE "SW-03 CONCRETE SIDEWALK" FOR JOINT PATTERN.

TABLE OF DRIVEWAY DIMENSIONS	
DIMENSION	ZONE
Y	5' OR 12:1 SLOPE, WHICH EVER DISTANCE IS GREATER
T	0'-6" RESIDENTIAL ZONES 0'-7" COMMERCIAL & INDUSTRIAL ZONES
W	24'-0" MIN. INDUSTRIAL & COMMERCIAL USE 16'-0" MIN. MAJOR & COLLECTOR STREET RESIDENTIAL USE 12'-0" MIN. LOCAL STREET RESIDENTIAL USE 36'-0" MAX. ALL DRIVEWAYS

1	R. KUMP	DWG REVISION	5/24/17
NO.	AUTHORIZED BY	REVISIONS	DATE

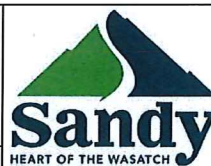

STANDARD DETAIL  
PUBLIC WORKS  
**DA-04**  
SIDEWALK ADJACENT  
TO CURB



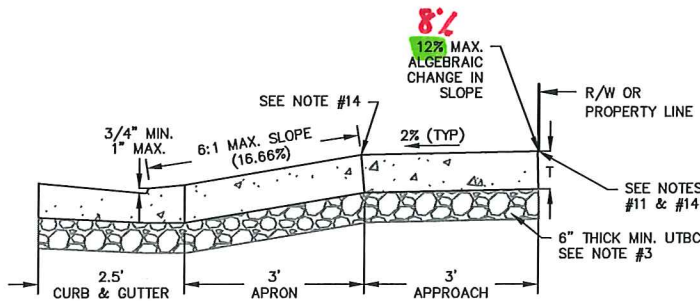
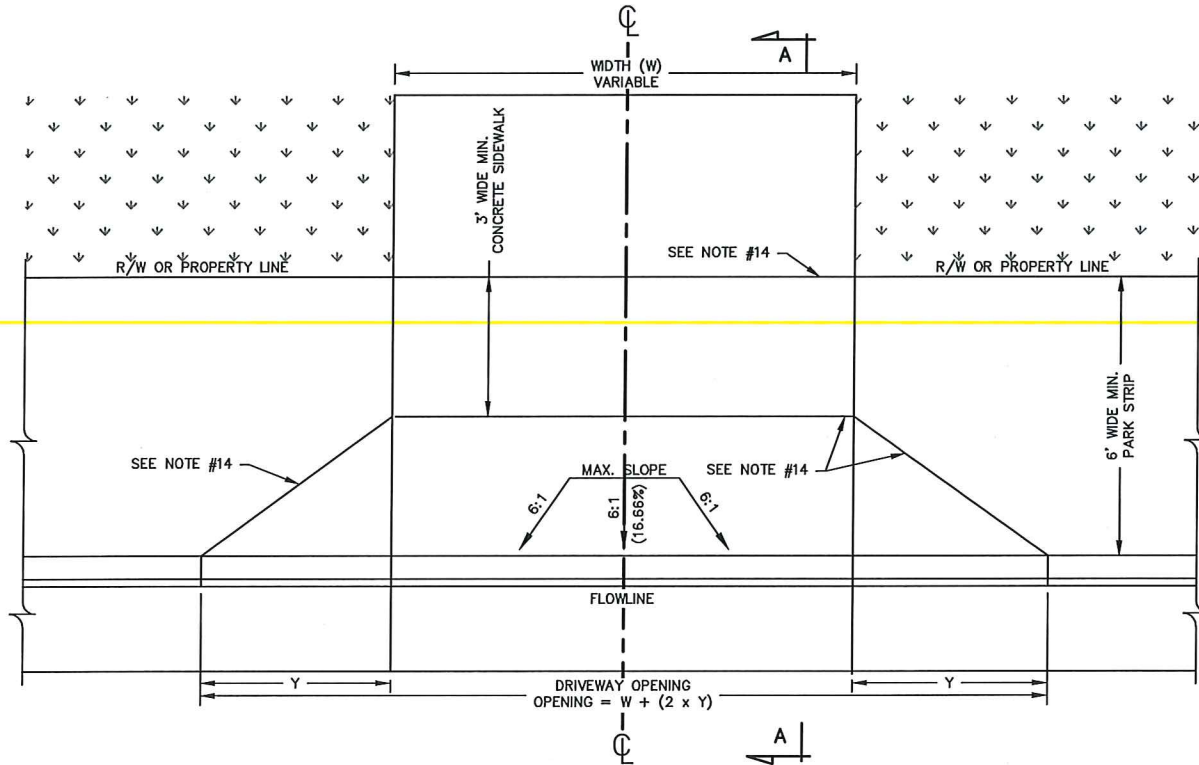

SECTION A-A

GENERAL NOTES

1. THE MAXIMUM GRADE AT WHICH DRIVEWAYS WILL BE ALLOWED TO BE BUILT IS <sup>10%</sup> 12% SLOPE, UNLESS PERMITTED BY ENGINEER. THE MINIMUM GRADE ALLOWED IS 2% SLOPE.
2. EDGE CONCRETE WITH 1/2" RADIUS EDGING TOOL.
3. HORIZONTAL CUT TO BE WIDTH OF DRIVEWAY PLUS THE "Y" DIMENSION AND THE FLARES ON EACH SIDE.
4. SAWCUT MUST BE SLOPED TOWARD THE GUTTER TO MATCH SLOPE OF APRON.
5. SIDEWALK SECTION MUST BE 6" MINIMUM THICKNESS THROUGH WIDTH OF DRIVEWAY OR BE REPLACED WITH 6" CONCRETE TO NEAREST JOINT BEYOND WIDTH OF DRIVEWAY.
6. NO OVERCUTTING WHERE CUTS MERGE.
7. PATCH ALL HOLES 1/2" OR LARGER IN EXPOSED SURFACE WITH UDOT APPROVED PATCHING COMPOUND.
8. GRIND FRONT EDGES TO AN APPROXIMATE 1-1/2" RADIUS.
9. GRIND SAWED SURFACE SO THAT NO BLADE MARKS APPEAR.
10. REMOVE AND REPLACE ALL DETERIORATED, WEAK OR UNSOUND CONCRETE.
11. ALL DRIVEWAYS MUST MAINTAIN A NEGATIVE SLOPE AWAY FROM THE HOME. NO DOWN SLOPING DRIVEWAYS WILL BE ALLOWED UNLESS APPROVED BY ENGINEER.
12. CONCRETE SHALL COMPLY WITH SANDY CITY STANDARD SPECIFICATION SECTION 03000.
13. USE 6" MIN. UNTREATED BASE COURSE MATERIAL. COMPACT TO 96% OF MAXIMUM DRY DENSITY.
14. PLACE 1/2" AC IMPREGNATED EXPANSION JOINT WHERE NOTED AND IN THE DRIVEWAY CENTERLINE IF "W" IS GREATER THAN 20'. EXPANSION JOINT SHALL BE FULL DEPTH OF CONCRETE PLUS 1", WITH TOP SET FLUSH WITH TOP OF CONCRETE.
15. SEE "SW-03 CONCRETE SIDEWALK" FOR JOINT PATTERN.

TABLE OF DRIVEWAY DIMENSIONS	
DIMENSION	ZONE
Y	5' OR 12:1 SLOPE, WHICH EVER DISTANCE IS GREATER
T	0'-6" RESIDENTIAL ZONES 0'-7" COMMERCIAL & INDUSTRIAL ZONES
W	24'-0" MIN. INDUSTRIAL & COMMERCIAL USE 16'-0" MIN. MAJOR & COLLECTOR STREET RESIDENTIAL USE 12'-0" MIN. LOCAL STREET RESIDENTIAL USE 36'-0" MAX. ALL DRIVEWAYS

1	R. KUMP	DWG REVISION	5/24/17
1	R. KUMP	PLAN CORRECTION	11/13/19
NO.	AUTHORIZED BY	REVISIONS	DATE

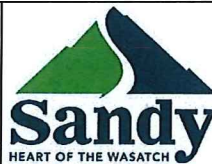

STANDARD DETAIL  
PUBLIC WORKS  
**DA-05**  
SIDEWALK ADJACENT  
TO CURB

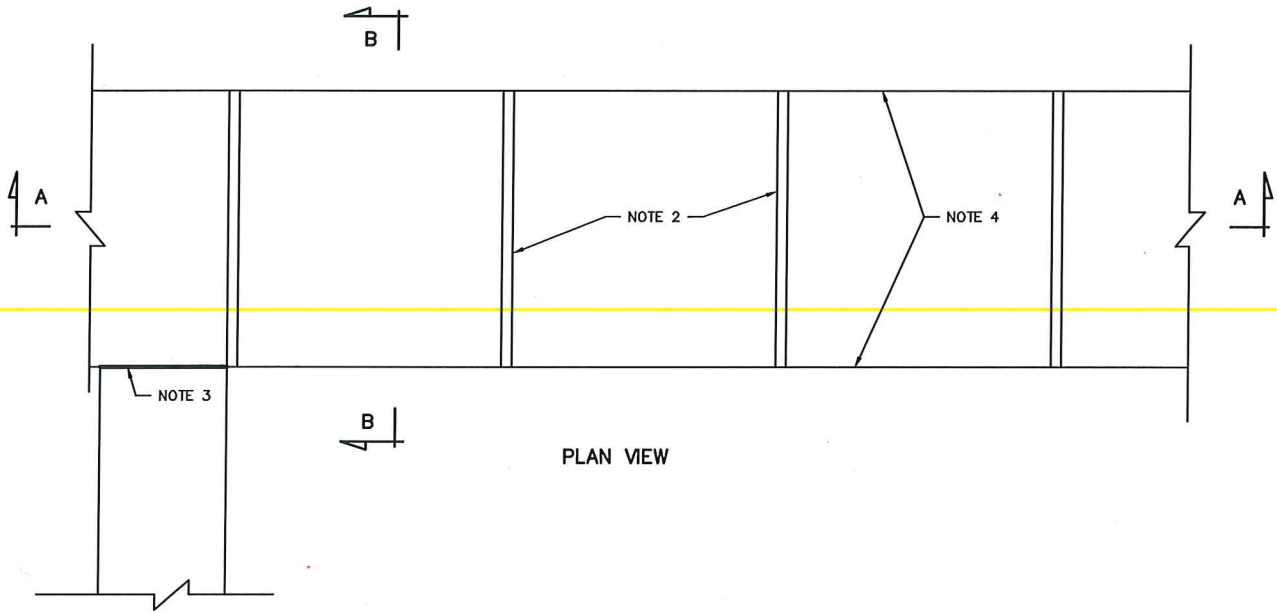

PLAN VIEW

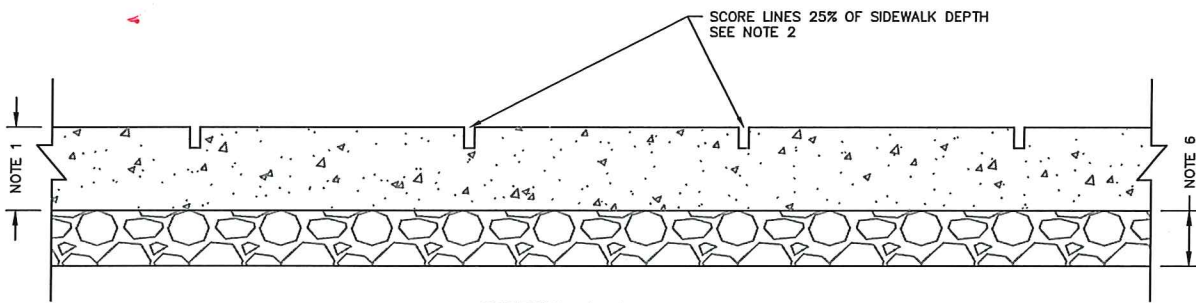

SECTION A-A

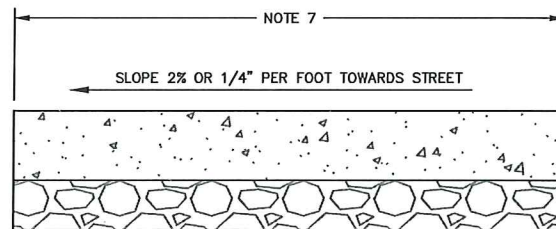

SECTION B-B

**GENERAL NOTES**

1. USE MONOLITHIC CONSTRUCTION. 4" THICK EXCEPT AT DRIVEWAYS WHERE A THICKNESS OF 7" IN COMMERCIAL AND INDUSTRIAL ZONE AREAS AND 6" IN RESIDENTIAL ZONE AREAS IS REQUIRED.
2. PLACE SCORE LINES AT INTERVALS EQUAL TO 1 TIMES THE WIDTH OF THE SIDEWALK UNIFORMLY PLACED ALONG LENGTH OF SIDEWALK. SEE SECTION 03050.
3. USE 1/2" EXPANSION JOINT FILLER MADE OF PREMOLDED BITUMINOUS OR SIMILAR MATERIAL AT INTERSECTIONS WITH PERPENDICULAR SIDEWALKS OR DRIVEWAYS. SEE SW-02 FOR WHEELCHAIR RAMP DETAILS.
4. EDGE SIDEWALK WITH 1/2" RADIUS EDGING TOOL. ROUND EDGES AT EXPANSION JOINTS TO A RADIUS OF 1/2".
5. WALKS SHALL BE FINISHED AS PER SECTION 03050.
6. USE A MINIMUM OF 4" UNTREATED BASE COURSE COMPACTED TO 96% AVERAGE OF THE MAXIMUM DRY DENSITY. (ASTM D698)
7. UNLESS SPECIFIED OTHERWISE, CONSTRUCT WIDTH OF SIDEWALK AS FOLLOWS:
  - A) 5 FEET IF SIDEWALK IS ADJACENT TO A PARKING STRIP OVER 1 FOOT WIDE, OR
  - B) 6 FEET IF SIDEWALK IS ADJACENT TO CURB AND GUTTER OR PARKING STRIPS LESS THAN 2 FOOT IN WIDTH, OR
  - C) MATCH TO EXISTING SIDEWALK EXTENSION WIDTHS IF 5' OR WIDER.
8. THE CLASS OF CONCRETE FOR SIDEWALK SHALL BE AA(AE), SEE SECTION 03000.

2.6 FEET

1	R. KUMP	DWG REVISION	5/24/17
NO.	AUTHORIZED BY	REVISIONS	DATE

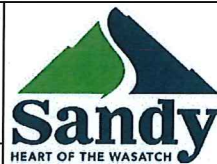

STANDARD DETAIL  
PUBLIC WORKS  
**SW-03**  
CONCRETE SIDEWALK

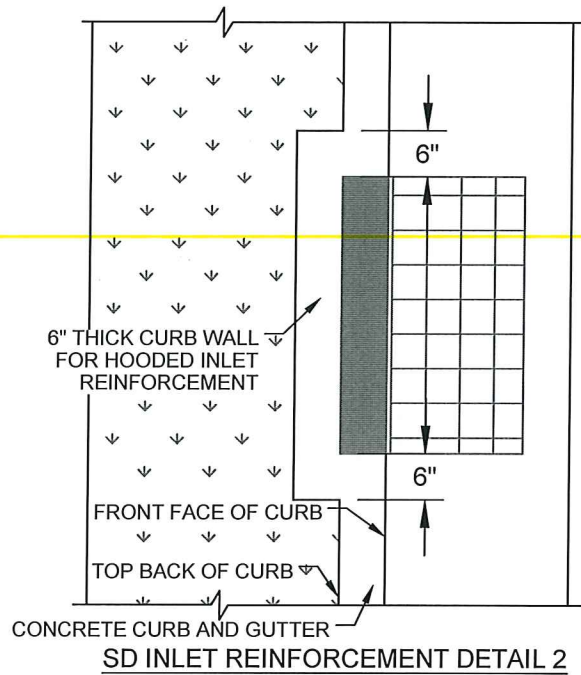
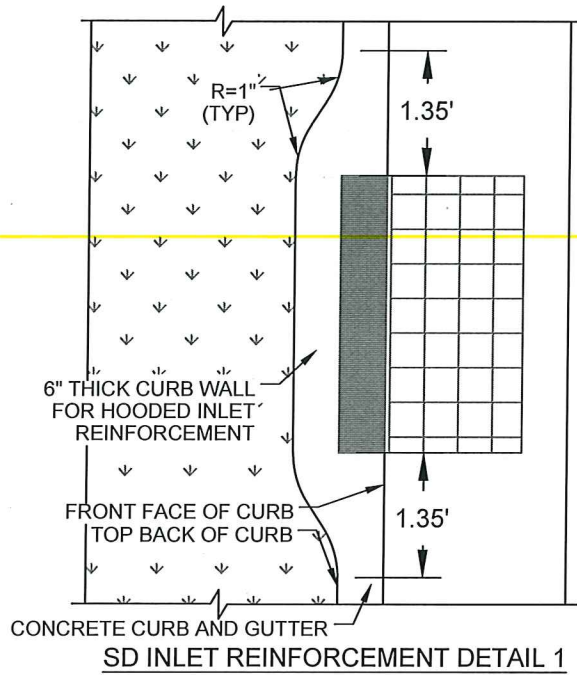

**NOTES:**

1. ADJACENT CONCRETE PARK STRIP COLOR AND PATTERN WILL BE DETERMINED BY THE ENGINEER. SEE SPECIFICATIONS FOR ADDITIONAL DETAILS.
2. CONCRETE ADJACENT TO CURB AND GUTTER SHALL BE THICKENED BEHIND SD INLET STRUCTURE. SEE MINIMUM DIMENSIONS OF THICKENED AREA IN DETAIL 2, THIS SHEET.
3. MINIMUM OFFSET OF 6" CONCRETE CURB WALL AROUND ALL HOODED GRATE INLET STRUCTURES NOT ADJACENT TO CONCRETE FLATWORK BEHIND CURB AND GUTTER.
4. FOR INLET RETROFITS, (2) EPOXY COATED #4 REBAR DOWELS EACH SIDE SHALL BE USED TO TIE CURB WALL INTO EXISTING CURB AND GUTTER. 3-INCH CLEARANCE ALL SIDES OF REBAR DOWELS.

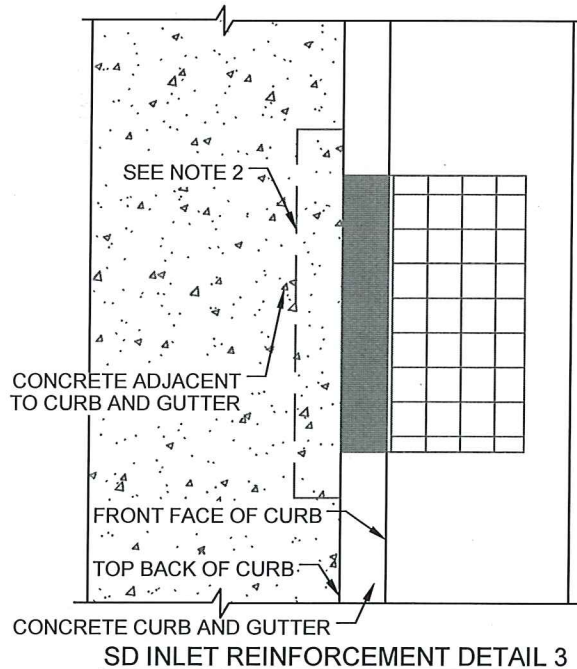

1	R. KUMP	DWG CREATED	01/2020
NO.	AUTHORIZED BY	REVISIONS	DATE

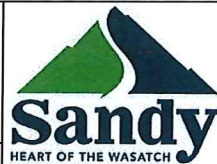

STANDARD DETAIL  
PUBLIC WORKS  
**CG-04**  
CURB AND GUTTER  
SD INLET DETAILS



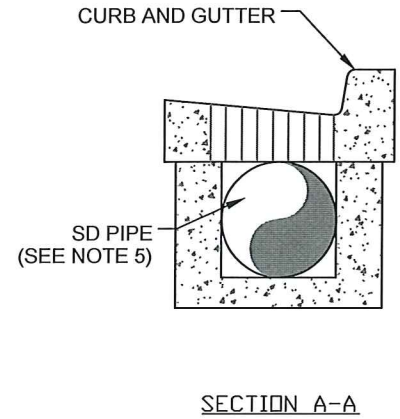
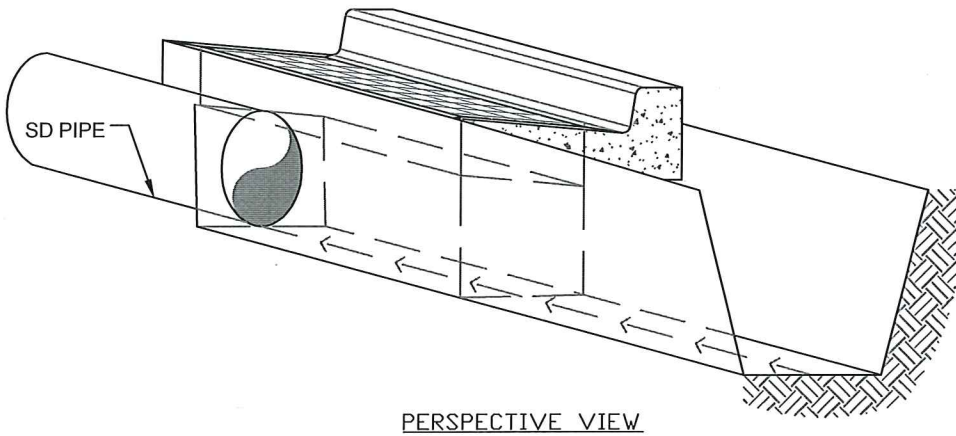
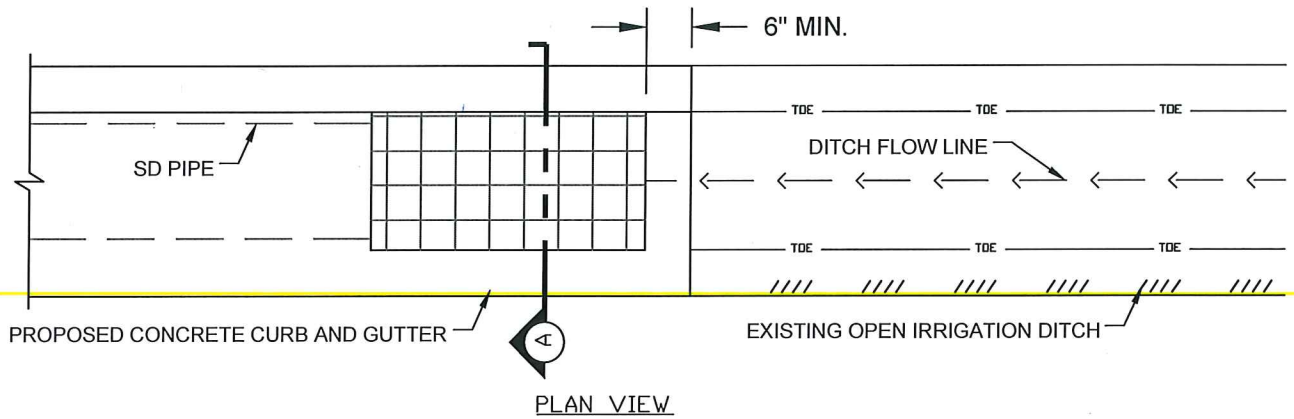

NOTES:

1. SEE CG-04 FOR HOODED INLET REINFORCEMENT DETAILS.
2. TRANSITION OPEN DRAINAGE DITCH SHAPE TO MATCH PROPOSED INLET PIPE WITH A CAST IN PLACE, CONCRETE STORM DRAIN BASIN.
3. ENSURE PROPER DRAINAGE SLOPE IS MAINTAINED FOR THE TRANSITION AREA AND STORM DRAIN PIPE.
4. UTILIZE A BICYCLE SAFE INLET GRATE AND FRAME IN THE TRANSITION AREA TO ENSURE POSSIBLE OVERFLOW EVENTS ARE CONTAINED IN THE NEW CURB AND GUTTER.
5. REFER TO BOX SIZING AND SPECIFICATIONS ON STD DETAILS SD-01 AND SD-02.

\*ENGINEER APPROVAL REQUIRED FOR USE\*

1	R. KUMP	DWG CREATED	01/2020
NO.	AUTHORIZED BY	REVISIONS	DATE

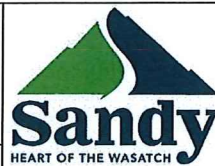

STANDARD DETAIL  
PUBLIC WORKS  
**CG-05**  
OPEN IRRIGATION DITCH TO  
CURB AND GUTTER SD DETAILS

1 2 3 4

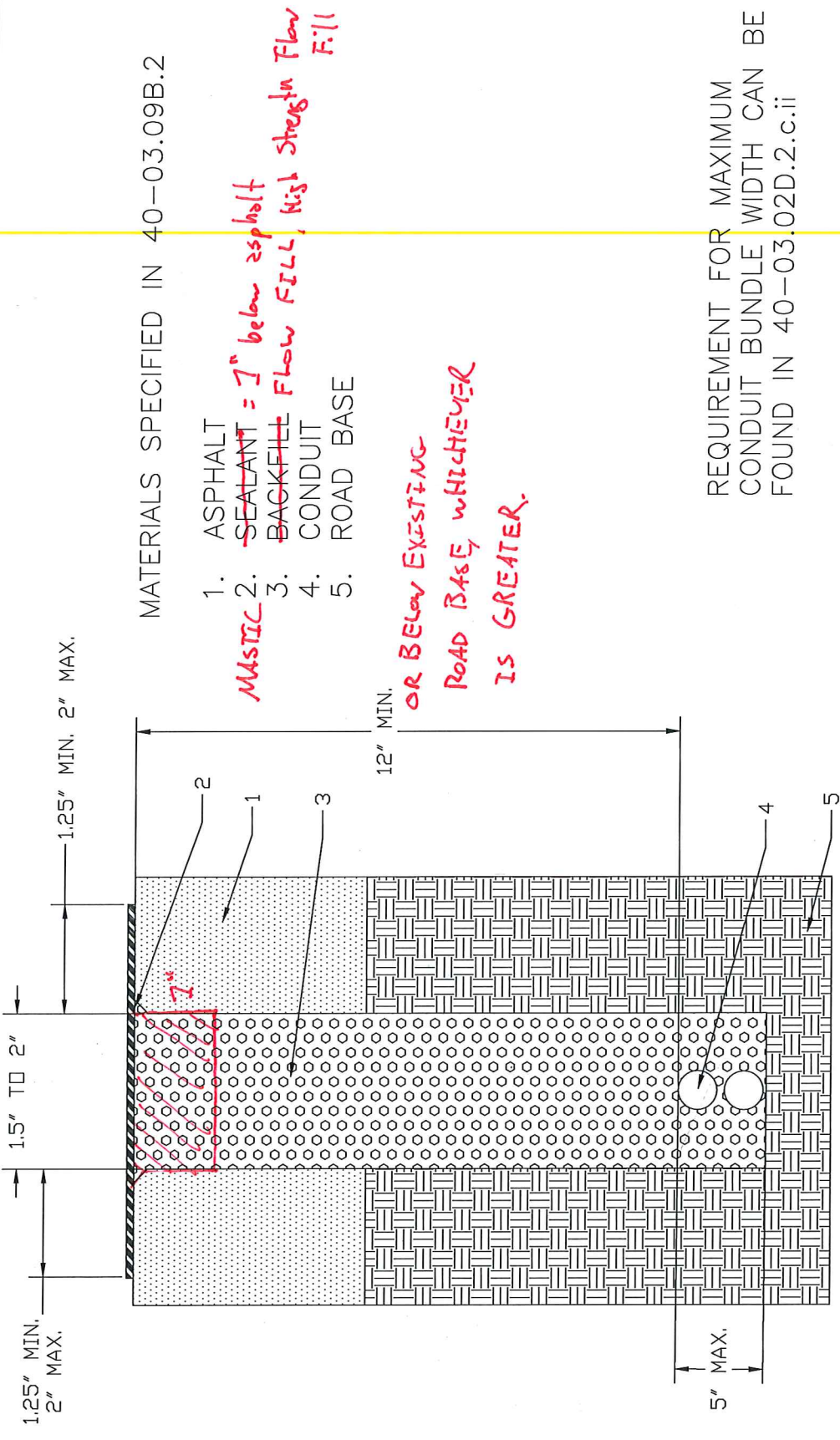

MATERIALS SPECIFIED IN 40-03.09B.2

1. ASPHALT
2. SEALANT = 7" below asphalt
3. BACKFILL FLOW FILL, High Strength Flow Fill
4. CONDUIT
5. ROAD BASE

MUSIC

OR BELOW EXISTING ROAD BASE, WHICHEVER IS GREATER.

REQUIREMENT FOR MAXIMUM CONDUIT BUNDLE WIDTH CAN BE FOUND IN 40-03.02D.2.c.ii

DETAILS FOR THIS DRAWING 40-03.08B.2.a CAN BE FOUND IN STANDARD APPLICATION SECTION 40-03.09B.2

RC-03  
Narrow trench  
Excavation

<del>GOOGLE FIBER</del>	
NAME:	1-1/2 TO 2 INCHES WIDE, 12 INCHES COVER, SEALANT OVERBAND, ASPHALT ONLY
TRACKING ID	DWG NO 40-03.08B.2.a v.002
NOT TO SCALE	

4 3 2 1

PART 7.0 A PUBLIC UTILITIES DEVELOPMENT STANDARDS AND REQUIREMENTS

7.01 GENERAL

- A. It is anticipated that when all requirements of the Sandy City Public Utilities Department have been met, a Public Utilities Final Review and Approval Letter will be issued. Signing of this letter by the Developer or his/her representative is required. This letter serves as a water availability letter, which is required by the Salt Lake County Board of Health.
- B. Drawing/drawings, signed, as approved by the City and the Developer will be issued for use by the Developer and Contractor.
- C. The following must be completed prior to holding a pre-construction meeting and beginning construction work on the site:
  - 1. Plans approved.
  - 2. Signing of the Public Utilities Final Review and Approval Letter.
  - 2-3. Storm Water Pollution Prevention Plan and Post-Construction Storm Water Maintenance Agreement approved if required.
  - 3-4. Utility line-work (in AutoCAD or GIS format) received from the Developer.
  - 4-5. Payment of fees.
  - 5-6. Posting of a bond.
- D. A pre-construction meeting is required once final approval has been granted. The pre-construction meeting shall be scheduled through Sandy City Public Works Department.
- E. All current Sandy City standards and specifications, State rules and regulations, ordinances, policies, and fees pertaining to the development shall be adhered to, including improvements in Public right-of-way and on private property.
- F. Additional requirements may be required for the project beyond those identified herein.

Formatted: List Paragraph, Left, Line spacing: single, No bullets or numbering, Tab stops: Not at -1"

7.02 DRAWINGS

- A. ~~24-inch x 36-inch size d~~Drawings shall be submitted electronically 24" x 36" in paper scale for review and approval of the Sandy City Public Utilities Department.
- B. All final drawings and calculations shall be stamped, signed, and dated by a ~~Consulting~~licensed Professional Engineer, licensed to practice in the State of Utah.
- C. All landscape drawings shall be stamped, signed, and dated by a licensed Architect.
- D. The location of all existing and proposed utility lines shall be shown on the drawings. Adequate separation from existing utilities shall be provided to meet the requirements of utility line owners.
- E. The following information shall be provided for existing and proposed utilities:
  - 1. Size and material of water lines.
  - 2. Size and location of meters, valves, fire hydrants, blowoffs, vaults, etc. relating to the water system.
  - 3. Size, slope, and material of storm drain and irrigation pipes.
  - 4. Top of lid/grate and flow line elevations of storm drain and irrigation structures.
  - 5. Type and location of streetlights, junction boxes, and electrical wiring. Power



**Sandy City Corporation - Prod. 12/18**

source shall be determined during construction.

6. Irrigation system details for irrigation boxes, head walls, head gates, and grates.

~~F. The following design information shall be provided for proposed detention and retention:~~

- ~~1. Maximum water surface perimeter line and maximum water surface elevation (based on finish grades in the pond area).~~
- ~~2. Peak volume.~~
- ~~3. Side and bottom slopes.~~
- ~~4. Discharge rate.~~
- ~~5. Proposed vegetation.~~
- ~~6. Outlet control structure details.~~

~~G. If the project is located in or near a flood plain, the existing flood plain area must be shown according to the Federal Emergency Management Agency (FEMA) flood plain maps.~~

H.F. The following notes shall be added to the Plat and Grading and Drainage Plan for residential subdivisions and individual residential lots:

1. No driveway shall be constructed so as to convey storm water runoff toward any building.

Formatted: Indent: Hanging: 0.5"

2. Each residential lot is required to retain all storm water on site, (except for the portion of the lot driveway that drains directly toward the street and/or to subdivision storm water flow control feature(s) as long as the downstream storm water system can accommodate the flows, during and after construction. This can be accomplished by use of swales, retention areas, berms, planter beds, underground infiltration, etc.

23. Properties are to be graded such that storm water runoff will drain away from structures and towards property boundaries. However, new development or redevelopment shall not increase the burden of storm water on neighboring and/or downstream properties. Storm water runoff shall be entirely controlled within the limits of project site. Perpetrating property owners may be liable for damages in civil courts due to damages caused to adjacent properties from runoff (including flows that existed before the new development or redevelopment occurred). Any concentrated flows leaving a site shall have an agreement/easement with the affected property owners.

Formatted: List Paragraph, Left, Line spacing: single, No bullets or numbering, Tab stops: Not at -1"

Formatted: Not Highlight

Formatted: Not Highlight

Formatted: Not Highlight

H.G. The following shall be added to the Plat and Grading and Drainage Plan for commercial projects or projects with a Homeowner Association (HOA):

1. Volume of detention/retention.
2. Note: For Storm Water Maintenance, refer to Post-Construction Storm Water Maintenance Agreement for maintenance of storm water system.

J.H. Drainage structures (inlets, combo boxes, junction boxes, and pipe to structure collar) on the drawings, shall reference the Sandy City Standard Detail as listed below (e.g. Single Curb Inlet Box per SW-02):

1. Single Curb Inlet Box: SD-02.
2. Double Curb Inlet Box: SD-03.
3. Combo Box: SD-04 A/B.

Sandy City Corporation - Prod. 12/18

4. Junction Box: SD-05 A/B.
5. Pipe to Structure Collar: SD-06.

~~K. The location and details of the detention basin outlet control structure shall be included on the drawing(s). The size of the orifice must be identified to the nearest 1/8-inch.~~

~~L. The location of existing water, storm water, and irrigation easements shall be shown on the drawings.~~

7.03 NOTES TO BE ADDED TO DRAWING(S)

A. WATER NOTES (to be added to the Utility Plan)

1. Notify Sandy City Public Utilities Inspector (801-568-7280), at least one business day (24 hours) prior to beginning construction.
2. A pre-construction meeting is required once final approval has been granted. The pre-construction meeting shall be scheduled through Sandy City Public Works Department.
3. All construction shall conform to the latest revision of the Sandy City Standard Specifications and Details for Municipal Construction and/or other requirements as set forth in the Public Utilities Final Review and Approval Letter established for the development. Specifications and details can be obtained on the Sandy City website.
4. Submittals are required to be approved by the ~~Consulting~~ Engineer for all bedding, backfill, pipe, meters, boxes, vaults, valves, fire hydrants, blowoffs, vaults, etc. relating to the water system. Submittals must have sufficient information to show that the proposed items conform to Sandy City standards and specifications.
5. Construction work shall be conducted in accordance with the Utah Pollution Discharge Elimination System (UPDES) regulations.
6. Water lines shall be installed 4-feet off lip of gutter on the north and/or east side of roadway. Water lines shall not be installed within or through parking stalls or under concrete pavement, unless water line is to be maintained by private property owner.
7. A minimum of 48-inches and a maximum 60-inches of cover from the top of the pipe to the finish grade is required.
8. For ~~construction east of the Utah Transit Authority's TRAX line, use~~ Ductile Iron Pipe, use thickness Class 52 or better.
9. For ~~construction west of Utah Transit Authority's TRAX line, use~~ Polyvinyl Chloride (PVC) Pipe, use class DR-14 or better. 10 gauge wire shall be placed on top of the pipe (per Sandy City specifications) for future relocation. No deflection in pipe joints will be allowed on PVC pipes.
10. All mechanical joints must be restrained using mega lugs ~~for DIP and ROMAC grip rings for PVC~~ or approved equal. ~~Mega lugs shall not be allowed on PVC pipe.~~
11. Use 6-inch compression type hydrant by Mueller Centurion or Clow Medallion. Existing hydrants required for fire protection that do not meet current standards shall be upgraded to meet current Sandy City standards and specifications.
12. When the distance from the water main to the fire hydrant is greater than 6-feet, an additional auxiliary valve shall be flanged to the fire hydrant.

Sandy City Corporation - Prod. 12/18

13. All dead ends shall be plugged with a 2-inch washout or end with a fire hydrant.
14. All ductile iron water lines, fittings, and valves shall be poly-bagged in accordance with Sandy City standards and specifications.
15. All water lines shall be bedded with sand (6-inches minimum below and 12-inches minimum on each side and on top of the pipe).

B. STORM WATER NOTES (to be added to the Grading and Drainage Plan)

1. Notify Sandy City Public Utilities Inspector (801-568-7280), at least one business day (24 hours) prior to beginning construction.
2. A pre-construction meeting is required once final approval has been granted. The pre-construction meeting shall be scheduled through Sandy City Public Works Department.
3. All construction shall conform to the latest revision of the Sandy City Standard Specifications and Details for Municipal Construction and/or other requirements as set forth in the Public Utilities Final Review and Approval Letter established for the development. Specifications and details can be obtained on the Sandy City website.
4. Submittals are required to be approved by the Consulting Engineer for all bedding, backfill, pipe, and structures (inlet boxes, combo boxes, and junction boxes). Submittals must have sufficient information to show that the proposed items conform to Sandy City standards and specifications.
5. Construction work shall be conducted in accordance with the Utah Pollution Discharge Elimination System (UPDES) regulations.
6. All materials and work done in UDOT right-of-way shall conform to UDOT standards and specifications ~~(delete if not applicable)~~.
7. Non-shrink grout shall be used wherever grout is required for the storm drain facilities.
8. Cut pipes off flush with the inside wall of the box or manhole and grout at connection of pipe to box to a smooth finish. Additionally, all jagged or sharp edges at pipe connections are to be removed and grouted smooth.
9. Grout between grade rings. For each inlet box that is located next to a curb, the curb and gutter Contractor is responsible to remove all protruding, jagged or sharp concrete edges and to grout between bottom of inlet lid frame and top of concrete box. Grout to create a smooth, beveled transition at all edges in clean out and inlet boxes. Grout around all edges of the restrictive orifice plate.
10. Remove snap ties, nails, rebar and other protrusions from the box or pipe inside surface, as well as all form work, plastic and cardboard.
11. Silt and debris are to be cleaned out of all inlet boxes, combo boxes, junction boxes, and pipe. The boxes and pipes are to be maintained in a clean condition until after the final bond release inspection.
12. Clean off all manhole lids and inlet grates of asphalt, concrete, tar or other adhesives to allow access.
13. Where a sump is required, the Sandy City Public Utilities Inspector shall be



Sandy City Corporation - Prod. 12/18

contacted prior to construction to provide an opportunity to check the volume of gravel and gravel gradation.

14. Signs must be posted near each inlet box located in a drinking water recharge zone, with the following words "WARNING THIS IS A DRINKING WATER AQUIFER RECHARGE AREA. DISPOSAL OF ANY WASTE MATERIALS IN THE STORM WATER IS STRICTLY PROHIBITED."
15. All inlet, combo and junction boxes shall be placed on 12-inch (min.) compacted stabilization material.
16. A video of all pipes must be completed before the 80% or 90% bond release and again before final bond release.
17. A representative of the manufacturer or supplier shall be on site during installation of oil/water separators, mechanical treatment devices, media filters,—and underground detention/retention systems. The manufacturer or supplier shall provide a letter stating that the system was installed per manufacturer's specifications. If it is unknown whether a representative is required to be present during installation, contact the Sandy City Public Utilities Inspector.
18. A stamped "Letter of Conformance" letter from the Consulting Design Engineer is required to be submitted to Sandy City Public Utilities Department, prior to 90% bond release, stating that verifying that the volume for retention/detention ponds was installed per the approved plans, storm water flow control elements and storm water treatment facilities (e.g. detention, retention, LID Best Management Practices, oil-water separators, sumps, etc.) were constructed according to the approved plans.

C. STREETLIGHT NOTES (to be added to the Utility Plan)

1. Notify Sandy City Public Utilities Inspector (801-568-7280), at least one business day (24 hours) prior to beginning construction.
- 4-2. The Developer is required to grant to the City a minimum of 15-foot wide streetlight easement (7.5-foot each side of pipe) for conduit and wires to the to the power source on private property.
- 2-3. A pre-construction meeting is required once final approval has been granted. The pre-construction meeting shall be scheduled through Sandy City Public Works Department.
- 3-4. All construction shall conform to the latest revision of the Sandy City Standard Specifications and Details for Municipal Construction and/or other requirements as set forth in the Public Utilities Final Review and Approval Letter established for the development. Specifications and details can be obtained on the Sandy City website.
- 4-5. Submittals are required to be approved by the Consulting Engineer for streetlights, junction boxes, and electrical wiring. Submittals must have sufficient information to show that the proposed items conform to Sandy City standards and specifications.
- 5-6. Installations shall be located as indicated on the approved plans for the project. Field modifications must be approved by the Sandy City Public Utilities Inspector.
- 6-7. Street light poles shall not be installed in a manner that will not hinder the operation

Formatted: Indent: Left: 1.5", No bullets or numbering

**Sandy City Corporation - Prod. 12/18**

of fire hydrants, underground water system isolation valves, and other utilities.

7-8. Installations within close proximity to trees shall be avoided unless approved by Sandy City Public Utilities Inspector.

8-9. Overhead power lines for streetlights are not allowed.

D. **IRRIGATION/LANDSCAPE NOTES (to be added to the Irrigation/Landscape Plan)**

1. Mulch: ~~After completion of all planting, all irrigated non-turf areas shall be covered with a minimum layer of four (4) inches of mulch to retain water, inhibit weed growth and moderate soil temperature. Non-porous material shall not be placed under the mulch. 4-inch mulch in all irrigated non-turf areas. If rock mulch, minimum is 3-inch. Bark mulch is not allowed in park strip. Rock mulch in park strip must be a minimum of 3".~~ After completion of all planting, all irrigated non-turf areas shall be covered with a minimum layer of four (4) inches of mulch to retain water, inhibit weed growth and moderate soil temperature. Non-porous material shall not be placed under the mulch. 4-inch mulch in all irrigated non-turf areas. If rock mulch, minimum is 3-inch.
2. Landscape Water Meter: A water meter and backflow prevention assembly that are in compliance with state code shall be installed for landscape irrigation systems, and the landscape water meter and backflow prevention assembly shall be separate from the water meter and backflow prevention assembly installed for indoor uses. The size of the meter shall be determined based on irrigation demand.
3. Pressure Regulation: A pressure regulating valve shall be installed and maintained by the consumer if the static service pressure exceeds 80 pounds per square inch (psi). The pressure-regulating valve shall be located between the landscape water meter and the first point of water use, or first point of division in the pipe, and shall be set at the manufacturer's recommended pressure for sprinklers.
4. Automatic controller: All irrigation systems shall include an electric automatic controller with multiple program and multiple repeat cycle capabilities and a flexible calendar program. All controllers shall be equipped with an automatic Rain Shut-off Device.
5. On slopes exceeding 30%, the irrigation system shall consist of Drip Emitters, Bubblers, or sprinklers with a maximum Precipitation Rate of 0.85 inches per hour and adjusted sprinkler cycle to eliminate Runoff.
6. Each valve shall irrigate a landscape with similar site, slope and soil conditions and plant materials with similar watering needs. Turf and non-turf areas shall be irrigated on separate valves.
7. Drip Emitters or a Bubbler shall be provided for each tree where practicable. Bubblers shall not exceed 1.5 gallons per minute per device. Bubblers for trees shall be on separate valve unless specifically exempted by Sandy City Public Utilities due to the limited number of trees on the project site.
8. Sprinklers shall have matched Precipitation Rate with each control valve circuit.
9. Check valves shall be required where elevation differences will cause low-head

Formatted: Font: (Default) Arial

Formatted: Normal

**Sandy City Corporation - Prod. 12/18**

- drainage. Pressure compensating valves and sprinklers shall be required where a significant variation in water pressure will occur within the irrigation system due to elevation differences.
10. Drip irrigation lines shall be placed underground or otherwise permanently covered, except for Drip emitters and where approved as a temporary installation. Filters and end flush valves shall be provided as necessary.
  11. Irrigation zones with overhead spray or stream sprinklers shall be designed to operate between 6:00 p.m. and 10:00 a.m. to reduce water loss from wind and evaporation. This would exclude drip or bubbler zones.
  12. Program valves for multiple repeat cycles where necessary to reduce runoff, particularly slopes and soils with slow infiltration rates.
  - ~~13. Following construction and prior to release of the secondary bond guarantee posted for the project, a Water Use Efficiency Review will be conducted by a Landscape Irrigation Auditor. The auditor shall be independent of the Contractor, Consulting Engineer, and Developer/Project Owner. The water performance audit will verify that the irrigation system complies with the minimum standards required by Sandy City ordinance. The minimum efficiency required for the irrigation system is 60% for distribution efficiency for all fixed spray systems and 70% distribution efficiency for all rotor systems. The auditor shall furnish a certificate to the City, designer, installer and Developer/Project Owner certifying compliance with the minimum distribution requirements. Compliance with this provision is required before the City will release the bond for this project.~~  
Following construction and prior to release of the secondary bond guarantee posted for the project, a Water Use Efficiency Review will be conducted by a Landscape Irrigation Auditor. The auditor shall be independent of the Contractor, Design Engineer, and Developer/Project Owner. The water performance audit will verify that the irrigation system complies with the minimum standards required by Sandy City ordinance. The minimum efficiency required for the irrigation system is 60% for distribution efficiency for all fixed spray systems and 70% distribution efficiency for all rotor systems. The auditor shall furnish a certificate to the City, designer, installer and Developer/Project Owner certifying compliance with the minimum distribution requirements. Also, form "Substantial Completion of Water Audit" must be completed and sent to Public Utilities. Compliance with this provision is required before the City will release the bond for this project.
  - 14.13. Plants which require different amounts of water shall be irrigated by separate valves. If one valve is used for a given area, only planters with similar water use shall be used in that area. Lawn areas and planters shall be irrigated by separate valves.
  - 15.14. A separate backflow prevention device shall be installed for the irrigation system.
  - 16.15. A rain sensing overriding device shall be utilized so that the irrigation system will automatically turn off in the event of rain.
  - 17.16. The irrigation system shall be designed to prevent overspray and water run-off onto adjacent-property, non-irrigated areas, walks, roadways or structures.
  - 18.17. An automatic irrigation system using pop-up sprinkler heads shall be required for all new landscapes. Low flow sprinkler heads shall be used wherever possible.

Formatted: Normal, Indent: First line: 0"



49-18. No irrigation of walkways or drive.

20-19. Water audit is required prior to bond being released. Suggest the audit be done within 60 days of installing irrigation and landscape.

**7.04 PUBLIC UTILITIES BONDS**

**A. GENERAL**

1. Public water, storm water, and street light improvements shall be bonded at 100% estimated cost as determined by Public Utilities.
2. Private water and storm water improvements shall be bonded at 50% estimated cost as determined by Public Utilities.

**B.** The following table summarizes bonding details/requirements for bonds required by Public Utilities:

**PUBLIC UTILITIES BOND DETAILS/REQUIREMENTS**

<u>Utility</u>	<u>Items Bonded</u>	<u>% Bond Release</u>	<u>Requirements for Bond Release</u>
<u>Water</u>	<u>Water system (e.g. waterlines, valves, vaults, services, meters, fire hydrants, etc.).</u>	<u>80%</u>	<ul style="list-style-type: none"> <li>• <u>Water system is complete and operating including:</u> <ul style="list-style-type: none"> <li>○ <u>All lines have satisfactorily passed bacteriological and pressure tests.</u></li> <li>○ <u>All valves, fire hydrants, and other appurtenances are fully functional.</u></li> <li>○ <u>All meter boxes, valve boxes, fire hydrants, other access vaults are set to final grade, and are accessible to city personnel.</u></li> </ul> </li> </ul>
		<u>90%</u>	<ul style="list-style-type: none"> <li>• <u>Water system is complete.</u></li> <li>• <u>Inspected and signed off by Public Utilities Inspector.</u></li> <li>• <u>All punch list items have been addressed.</u></li> </ul>
		<u>100%</u>	<ul style="list-style-type: none"> <li>• <u>1-year warranty period is complete.</u></li> <li>• <u>All punch list items have been addressed.</u></li> </ul>
<u>Storm Water</u>	<u>Storm water system (e.g. storm drains, boxes, manholes, storm water flow control elements, LID BMPs, storm water treatment facilities, etc.).</u>	<u>90%</u>	<ul style="list-style-type: none"> <li>• <u>Storm water system is complete and operating.</u></li> <li>• <u>Inspected and signed off by Public Utilities Inspector.</u></li> <li>• <u>"Letter of Conformance" has been received.</u></li> <li>• <u>All punch list items have been addressed.</u></li> </ul>
		<u>100%</u>	<ul style="list-style-type: none"> <li>• <u>1-year warranty period is complete.</u></li> <li>• <u>All punch list items have been addressed.</u></li> </ul>
<u>Storm Water - SWPPP</u>	<u>Construction/long-term BMPs and individual lot storm water flow control features.</u>	<u>50%</u>	<ul style="list-style-type: none"> <li>• <u>Storm water system is complete and operating.</u></li> <li>• <u>Inspected and signed off by Public Utilities Inspector.</u></li> <li>• <u>"Letter of Conformance" received.</u></li> <li>• <u>Disturbed areas have been seeded.</u></li> <li>• <u>All punch list items have been addressed.</u></li> </ul>
		<u>100%</u>	<ul style="list-style-type: none"> <li>• <u>1-year warranty period complete.</u></li> <li>• <u>NOT has been submitted and approved</u></li> <li>• <u>All punch list items have been addressed.</u></li> </ul>

- Formatted: Indent: Left: 1", No bullets or numbering
- Formatted: Indent: Left: 1.5", No bullets or numbering
- Formatted: Indent: Left: 1", Hanging: 0.5"
- Formatted: Indent: Left: 1", No bullets or numbering
- Formatted: Centered, Indent: Left: 0"
- Formatted: Font: Bold, No underline
- Formatted: Indent: Left: 1", No bullets or numbering
- Formatted: Font: Bold
- Formatted: Centered
- Formatted Table
- Formatted: Centered
- Formatted: Font: Bold
- Formatted: Left
- Formatted: Normal, No bullets or numbering
- Formatted: Font: (Default) Arial
- Formatted: Indent: Left: 0", Hanging: 0.11", Bulleted + Level: 1 + Aligned at: 0.25" + Indent at: 0.5"
- Formatted: List Paragraph, Left, Indent: Left: 0.11", Hanging: 0.19", Bulleted + Level: 2 + Aligned at: 0.75" + Indent at: 1"
- Formatted: Font: (Default) Arial
- Formatted: Normal, No bullets or numbering
- Formatted: Font: (Default) Arial
- Formatted: Font: (Default) Arial
- Formatted: Normal, No bullets or numbering
- Formatted: Font: (Default) Arial
- Formatted: Left
- Formatted: Normal, No bullets or numbering
- Formatted: Font: (Default) Arial
- Formatted: List Paragraph, Left, Indent: Left: -0.01", Hanging: 0.13", Bulleted + Level: 1 + Aligned at: 0.25" + Indent at: 0.5"
- Formatted: Font: (Default) Arial
- Formatted: Font: (Default) Arial
- Formatted: Left
- Formatted: Normal, No bullets or numbering
- Formatted: Font: (Default) Arial
- Formatted: List Paragraph, Left, Indent: Left: -0.01", Hanging: 0.13", Bulleted + Level: 1 + Aligned at: 0.25" + Indent at: 0.5"
- Formatted: Font: (Default) Arial

Sandy City Corporation - Prod. 12/18

Streetlights	Streetlights	90%	<ul style="list-style-type: none"> <li>Streetlights are complete and operating.</li> <li>All punch list items have been addressed.</li> </ul>
		100%	<ul style="list-style-type: none"> <li>1-year warranty period complete.</li> <li>All punch list items have been addressed.</li> </ul>

Formatted: Left

Formatted: Font: (Default) Arial

Formatted: Normal, No bullets or numbering

Formatted: List Paragraph, Left, Indent: Left: -0.01", Hanging: 0.13", Bulleted + Level: 1 + Aligned at: 0.25" + Indent at: 0.5"

Formatted: Font: (Default) Arial

Formatted: Font: (Default) Arial

Formatted: Numbered + Level: 1 + Numbering Style: A, B, C, ... + Start at: 1 + Alignment: Left + Aligned at: 0.5" + Indent at: 1"

Formatted: Indent: Left: 1", Hanging: 0.5", Numbered + Level: 2 + Numbering Style: 1, 2, 3, ... + Start at: 1 + Alignment: Left + Aligned at: 1" + Indent at: 1.25"

Formatted: Indent: Left: 1", Hanging: 0.5", Numbered + Level: 2 + Numbering Style: 1, 2, 3, ... + Start at: 1 + Alignment: Left + Aligned at: 1" + Indent at: 1.25"

Formatted: Indent: Left: 1", Hanging: 0.5", Numbered + Level: 2 + Numbering Style: 1, 2, 3, ... + Start at: 1 + Alignment: Left + Aligned at: 1" + Indent at: 1.25"

7.045 WATER

A. GENERAL

1. The City shall be given the first right of refusal to purchase any water rights accompanying the property in the development.
2. All water mains and service laterals shall be installed, pressure tested and bacteriological samples taken in accordance with the Sandy City Standard Specification and Details for Municipal Construction.
3. Any existing water facilities (lines, meters, hydrants, etc.) owned by Sandy City which are found to not meet current City standards and specifications or that are adversely affected by the development during construction, requiring them to be upgraded, moved or otherwise altered to facilitate maintenance (as determined by the City), shall be upgraded, moved, or altered by the Developer at no cost to the City. Water meters/connections that are older than five (5) years, need to be brought up to current Sandy City standards and specifications.
4. Fire flows and fire hydrant placement will be determined by the Fire Marshall during site plan review.
5. Water meter placement location will be determined by Sandy City Public Utilities Department during site plan review and water meter size shall be determined by owner's representative.
6. The Developer is required to pay a water line reimbursement fee based on the frontage of the property for pipe larger than 8-inches that was installed by the City.
7. The Developer is required to grant to the City a minimum of 15-foot wide water line easement (7.5-feet each side of pipe) for all water main lines, around fire hydrants, and around water meters installed on private property, that will be maintained by the City. Easement shall be on a signed standard easement form (template is available from Sandy City Public Utilities) or called out on the plat. Easements shall be completed and submitted to the City after all waterlines have been installed and before the 90% bond release. Structures, buildings, and other utilities shall not be installed within the waterline easement.
8. A separation of 2-feet shall be provided between water services on a ductile iron waterline and a separation of 3-feet shall be provided between water services on a PVC waterline.
9. Future waterline stubs such as water main, fire line and water meter box, and water service lateral shall not be allowed unless a final design has been accepted by Sandy City Public Utilities, on a case-by-case basis.

Formatted: Indent: Left: 1", Hanging: 0.5", Numbered + Level: 2 + Numbering Style: 1, 2, 3, ... + Start at: 1 + Alignment: Left + Aligned at: 1" + Indent at: 1.25"

Formatted: Indent: Left: 1", Hanging: 0.5", Numbered + Level: 2 + Numbering Style: 1, 2, 3, ... + Start at: 1 + Alignment: Left + Aligned at: 1" + Indent at: 1.25"

Formatted: Indent: Left: 1", Hanging: 0.5", Numbered + Level: 2 + Numbering Style: 1, 2, 3, ... + Start at: 1 + Alignment: Left + Aligned at: 1" + Indent at: 1.25"

Formatted: Indent: Left: 1", Hanging: 0.5", Numbered + Level: 2 + Numbering Style: 1, 2, 3, ... + Start at: 1 + Alignment: Left + Aligned at: 1" + Indent at: 1.25"

Formatted: Indent: Left: 1", Hanging: 0.5", Numbered + Level: 2 + Numbering Style: 1, 2, 3, ... + Start at: 1 + Alignment: Left + Aligned at: 1" + Indent at: 1.25"

Formatted: Indent: Left: 1", Hanging: 0.5", Numbered + Level: 2 + Numbering Style: 1, 2, 3, ... + Start at: 1 + Alignment: Left + Aligned at: 1" + Indent at: 1.25"

Formatted: Numbered + Level: 1 + Numbering Style: A, B, C, ... + Start at: 1 + Alignment: Left + Aligned at: 0.5" + Indent at: 1"

B. DESIGN

1. Water line pipe material:
  - a) If the project is located west of the Utah Transit Authority's TRAX line, PVC C-900 (DR-14) shall be used for pipe sizes 6-inch thru 12-inch in diameter (see Section 02669 – Water Supply Piping).
  - b) All other pipe shall be Ductile Iron Class 52 or better (see Section 02669

Formatted: Indent: Left: 1", Hanging: 0.5", Numbered + Level: 2 + Numbering Style: 1, 2, 3, ... + Start at: 1 + Alignment: Left + Aligned at: 1" + Indent at: 1.25"

Formatted: Indent: Left: 1.5", Hanging: 0.5", Numbered + Level: 3 + Numbering Style: a, b, c, ... + Start at: 1 + Alignment: Left + Aligned at: 1.63" + Indent at: 1.75"

Formatted: Indent: Left: 1.5", Hanging: 0.5", Numbered + Level: 3 + Numbering Style: a, b, c, ... + Start at: 1 + Alignment: Left + Aligned at: 1.63" + Indent at: 1.75"

**Sandy City Corporation - Prod. 12/18**

– Water Supply Piping), unless directed otherwise by Sandy City Public Utilities.

- c) High Density Polyethylene pipe (see Section 02669 – Water Supply Piping) may be used in certain locations/situations only as directed by Sandy City Public Utilities.
- 2. Water line shall be installed 4-feet off lip of gutter on the north and/or east side of roadway.
- 3. Water lines shall not be installed within or through parking stalls or under concrete pavement, unless water line is to be maintained by private property owner.
- 4. Water meters that are 1 ½-inch or larger need to be located in a meter vault (See standard details WTR-10 thru WTR-12).
- 5. A separate landscape meter is required for commercial projects and projects with common landscaped areas. Call out a landscape meter both in the Utility Plan and in the Irrigation Plan. This meter can be a separate connection to the water main or it can come off the service line after the water meter.
- 6. All water meters shall be placed in a landscaped area and not in an existing or future driveway.
- 7. The horizontal distance between water lines and sanitary sewer lines shall be at least 10 feet. Where a water line and a sewer line must cross, the water line shall be at least 18 inches above the sewer line. A variance to this rule may be allowed on a case-by-case basis with additional requirements as approved by Sandy City Public Utilities and/or Utah Division of Drinking Water. Water lines and sewer lines shall not be installed in the same trench.

**Formatted:** Indent: Left: 1.5", Hanging: 0.5", Numbered + Level: 3 + Numbering Style: a, b, c, ... + Start at: 1 + Alignment: Left + Aligned at: 1.63" + Indent at: 1.75"

**Formatted:** Indent: Left: 1", Hanging: 0.5", Numbered + Level: 2 + Numbering Style: 1, 2, 3, ... + Start at: 1 + Alignment: Left + Aligned at: 1" + Indent at: 1.25"

**Formatted:** Indent: Left: 1", Hanging: 0.5", Numbered + Level: 2 + Numbering Style: 1, 2, 3, ... + Start at: 1 + Alignment: Left + Aligned at: 1" + Indent at: 1.25"

**Formatted:** Indent: Left: 1", Hanging: 0.5", Numbered + Level: 2 + Numbering Style: 1, 2, 3, ... + Start at: 1 + Alignment: Left + Aligned at: 1" + Indent at: 1.25"

**Formatted:** Indent: Left: 1", Hanging: 0.5", Numbered + Level: 2 + Numbering Style: 1, 2, 3, ... + Start at: 1 + Alignment: Left + Aligned at: 1" + Indent at: 1.25"

**Formatted:** Indent: Left: 1", Hanging: 0.5", Numbered + Level: 2 + Numbering Style: 1, 2, 3, ... + Start at: 1 + Alignment: Left + Aligned at: 1" + Indent at: 1.25"

**Formatted:** Indent: Left: 1", Hanging: 0.5", Numbered + Level: 2 + Numbering Style: 1, 2, 3, ... + Start at: 1 + Alignment: Left + Aligned at: 1" + Indent at: 1.25"

**7.056 STORM WATER**

**A. GENERAL**

- 1. The City shall be given the first right of refusal to purchase any irrigation shares accompanying the property in the development.
- 2. Public storm drains should be placed in public rights-of-way to service upstream properties. If storm drains must be placed outside the public rights-of-way, recorded easements are required.
  - a) The Developer is required to shall grant to the City, a 20' wide storm drain or irrigation easement (10 feet each side of pipe/structure) for all storm drains, irrigation lines, and around structures installed on private property, that will be maintained by the City.
  - b) Easements shall be on a signed standard easement form (template is available from Sandy City Public Utilities).
  - c) Easements shall be completed and submitted to the City after all storm drains have been installed and before the 90% bond release. Structures, buildings, and other utilities shall not be installed within the waterline easement.
  - d) Easements shall be exclusive and granted to Sandy City.
  - e) Storm drains and irrigation lines are generally required to be placed in the center of the easement; however, on a case by case basis deviation from this standard can be addressed.
  - f) At all times, a horizontal minimum of 10 feet is required between the storm drain or irrigation line and the edge of the easement.
  - g) The easement shall be accessible from public rights-of way and shall be free of obstructions (including trees).
  - h) Fencing, permanent structures, buildings and other utilities are not be allowed within the easement area.
  - i) The easement area shall allow unrestricted 24 hour/day, 365 days per year access for all purposes related to the ownership, operation, maintenance.

**Formatted:** Font color: Auto

**Formatted:** List Paragraph, Left, Line spacing: single, No bullets or numbering, Tab stops: Not at -1"

**Formatted:** Font color: Auto

**Formatted:** Font color: Auto

**Formatted:** Font color: Auto

**Formatted:** Font color: Auto

**Formatted:** Font color: Auto

**Formatted:** Font color: Auto

**Formatted:** Font color: Auto

**Formatted:** Font color: Auto



alteration, repair, inspection and replacement of storm drain or irrigation line.  
j) In situations where encroachment into the easement with improvements cannot be avoided, a utility easement encroachment permit and shared utility agreement is required from the property owner.

2. \_\_\_\_\_

3. Any existing storm drain and irrigation facilities (pipes, manholes, detention ponds, etc.) owned by Sandy City which are found to not meet current City standards and specifications or that are adversely affected by the development during construction, requiring them to be upgraded, moved or otherwise altered to facilitate maintenance (as determined by the City), shall be upgraded, moved, or altered by the Developer at no cost to the City.
4. For projects that adjoin the East Jordan Canal or Jordan and Salt Lake Canal rights-of-way, the Developer shall obtain a letter of approval from Salt Lake City Public Utilities, a copy of which should be submitted to Sandy City Public Utilities. The Developer shall first send a copy of the site plans, along with the enclosed memorandum, to Salt Lake City Public Utilities. It is recommended that this process be started as soon as possible so as not to delay the construction of the project.
5. For projects that the storm drain system connects to a County Storm Drain System, the Developer should submit a letter, giving approval to connect to the storm drain facilities, from Salt Lake County. It is recommended that this process be started as soon as possible so as not to delay the construction of the project.
6. For projects that the storm drain system connects to UDOT Storm Drain System, the Developer should submit a letter, giving approval to connect to the storm drain facilities from UDOT. It is recommended that this process be started as soon as possible so as not to delay the construction of the project.
7. \_\_\_\_\_ A letter of approval from the irrigation company is required if storm drain and/or storm drain outfall is located on irrigation company property.

7-8. A stamped "Letter of Conformance" from the engineer shall be submitted to Public Utilities for final construction approval stating that storm water flow control elements and storm water treatment facilities (e.g. detention, retention, LID Best Management Practices, oil-water separators, mechanical treatment devices, etc.) were constructed according to the approved plans.

B. DESIGN

1. Design of storm water systems shall meet the requirements found in Part 7.0 B - Storm Water Design Criteria.
1. It is required that the intensities used in the Storm Water Master Plan be used in the calculation of storm water runoff. The type of storm required is indicated below. Depth duration frequency tables for different types of storms, based on the Storm Water Master Plan, are included at the end of this specification. Please note that rainfall intensities are to be adjusted based on the mean elevation of the site.
2. Storm water runoff flows shall be calculated using the Rational Method.
3. Storm drain conveyance facilities (pipes, gutters, channels, swales, boxes, manholes, and inlets) shall be designed for the 10-year, 3-hour storm event.
4. Storm runoff shall not be allowed to run onto neighboring properties. If this cannot be avoided, an easement is required or retention for the 100-year, 24-hour storm event shall be provided on-site.
5. Detention and retention facilities:
  - a) The City encourages a Low Impact Development (LID) approach to managing storm water that meets the objective of mirroring the predevelopment hydrology (water quality and storm water release rate/volume). See Section 3.04 - Low

Formatted: No bullets or numbering

Formatted: QuickFormat5, Justified, Indent: Left: 1.75", Line spacing: Exactly 9.7 pt, Tab stops: -1", Left

Formatted: List Paragraph, Left, Line spacing: single, No bullets or numbering, Tab stops: Not at -1"

Formatted: Font color: Auto

Formatted: Indent: Left: 1", Hanging: 0.5", Numbered + Level: 2 + Numbering Style: 1, 2, 3, ... + Start at: 1 + Alignment: Left + Aligned at: 1" + Indent at: 1.25"

Formatted: QuickFormat5, Justified, Indent: Left: 1", Hanging: 0.5", Line spacing: Exactly 9.7 pt, Numbered + Level: 2 + Numbering Style: 1, 2, 3, ... + Start at: 1 + Alignment: Left + Aligned at: 1" + Indent at: 1.25", Tab stops: -1", Left

Formatted: QuickFormat5, Justified, Indent: Left: 1", Hanging: 0.5", Line spacing: Exactly 9.7 pt, Numbered + Level: 2 + Numbering Style: 1, 2, 3, ... + Start at: 1 + Alignment: Left + Aligned at: 1" + Indent at: 1.25", Tab stops: -1", Left

Formatted: QuickFormat5, Justified, Indent: Left: 1", Hanging: 0.5", Line spacing: Exactly 9.7 pt, Numbered + Level: 2 + Numbering Style: 1, 2, 3, ... + Start at: 1 + Alignment: Left + Aligned at: 1" + Indent at: 1.25", Tab stops: -1", Left

Formatted: QuickFormat5, Justified, Indent: Left: 1", Hanging: 0.5", Line spacing: Exactly 9.7 pt, Numbered + Level: 2 + Numbering Style: 1, 2, 3, ... + Start at: 1 + Alignment: Left + Aligned at: 1" + Indent at: 1.25", Tab stops: -1", Left

- Impact Development within this specification. This may include facilities such as bio-retention, rain gardens, retention, and/or detention):
- b) Following are design storm and release rate requirements:
    - i. Bio-retention, rain gardens, and retention areas shall be designed for the 10-year, 3-hour storm event.
    - ii. Storm water release rates from the development site shall be limited in a 10-year, 3-hour storm event, to 0.2 cfs/acre. For areas located in a Sensitive Overlay Area, storm water release rates from the development site shall be limited in a 25-year, 3-hour storm event, to 0.2 cfs/acre. However, there are some areas in the City that may require a release rate of 0.1 cfs/acre due to insufficient downstream system capacity).
    - e) Adequate overflow capacity shall be provided for the 100-year, 3-hour storm event.
    - d) It shall be demonstrated that in a 100-year, 3-hour storm event, runoff flows will be safely conveyed to the street and will not flood structures. If the 100-year, 3-hour storm runoff flows cannot be safely conveyed to the street and without flooding structures, then retention for the 100-year, 24-hour storm event shall be provided on-site.
    - e) The water level of detention/retention in driving and parking areas should be no deeper than 12-inch at the peak volume.
    - f) The permeability rate of the soil may be used as a discharge rate for detention/retention ponds.
    - g) Detention ponds shall be either grass- or concrete-lined. Retention ponds shall be grass-lined. Underground detention or retention facilities, and Low Impact Development detention/retention facilities will be approved by Sandy City Public Utilities on a case-by-case basis.
    - h) Adequate access to the detention/retention facilities shall be provided for maintenance.
    - i) The orifice opening of detention-basin control structures shall be located at the bottom of the outlet pipe.
    - j) The volume of all surface detention/retention ponds that are designed and submitted on a grading and drainage plan, shall be surveyed by a licensed surveyor to confirm the finished volume after construction. A signed and stamped letter must be provided to Sandy City documenting the constructed volume.
  - 6. All pipes within Sandy City right-of-way or that will be maintained by Sandy City must have a minimum diameter of 15-inch and shall be Reinforced Concrete Pipe (RCP). Pipes on private property 12-inch or larger (and not maintained by Sandy City) shall be RCP or polypropylene pipe (ADS HP storm pipe or approved equal). For pipes smaller than 12-inch, PVC SDR 35 may be used.
  - 7. All pipes shall have a minimum cover of 12-inch to the top of the pipe bell.
  - 8. The minimum pipe slope required is 0.5%.
  - 9. A maximum of 300 linear feet is allowed between clean out manholes.
  - 10. A maximum of 600 linear feet is allowed between curb inlet boxes in roadways.
  - 11. All drainage structures shall conform to Sandy City Standard Specifications and Details for Municipal Construction. Note that a combination box should be used any time there are two or more pipes connecting to the same box where an inlet is proposed. Junction boxes are required on all junctions in both private and public storm drain systems.

**Formatted:** QuickFormat5, Line spacing: Exactly 9.7 pt, Tab stops: -1", Left

**Formatted:** QuickFormat5, Indent: Left: 1", Hanging: 0.5", Line spacing: Exactly 9.7 pt, Numbered + Level: 2 + Numbering Style: 1, 2, 3, ... + Start at: 1 + Alignment: Left + Aligned at: 1" + Indent at: 1.25", Tab stops: -1", Left

**Formatted:** QuickFormat5, Line spacing: Exactly 9.7 pt, Tab stops: -1", Left

**Formatted:** QuickFormat5, Justified, Indent: Left: 1", Hanging: 0.5", Line spacing: Exactly 9.7 pt, Numbered + Level: 2 + Numbering Style: 1, 2, 3, ... + Start at: 1 + Alignment: Left + Aligned at: 1" + Indent at: 1.25", Tab stops: -1", Left

**Formatted:** QuickFormat5, Line spacing: Exactly 9.7 pt, Tab stops: -1", Left

**Formatted:** QuickFormat5, Justified, Indent: Left: 1", Hanging: 0.5", Line spacing: Exactly 9.7 pt, Numbered + Level: 2 + Numbering Style: 1, 2, 3, ... + Start at: 1 + Alignment: Left + Aligned at: 1" + Indent at: 1.25", Tab stops: -1", Left

**Formatted:** QuickFormat5, Line spacing: Exactly 9.7 pt, Tab stops: -1", Left

**Formatted:** QuickFormat5, Justified, Indent: Left: 1", Hanging: 0.5", Line spacing: Exactly 9.7 pt, Numbered + Level: 2 + Numbering Style: 1, 2, 3, ... + Start at: 1 + Alignment: Left + Aligned at: 1" + Indent at: 1.25", Tab stops: -1", Left

**Formatted:** QuickFormat5, Line spacing: Exactly 9.7 pt, Tab stops: -1", Left

**Formatted:** QuickFormat5, Justified, Indent: Left: 1", Hanging: 0.5", Line spacing: Exactly 9.7 pt, Numbered + Level: 2 + Numbering Style: 1, 2, 3, ... + Start at: 1 + Alignment: Left + Aligned at: 1" + Indent at: 1.25", Tab stops: -1", Left

**Formatted:** QuickFormat5, Line spacing: Exactly 9.7 pt, Tab stops: -1", Left

**Formatted:** QuickFormat5, Justified, Indent: Left: 1", Hanging: 0.5", Line spacing: Exactly 9.7 pt, Numbered + Level: 2 + Numbering Style: 1, 2, 3, ... + Start at: 1 + Alignment: Left + Aligned at: 1" + Indent at: 1.25", Tab stops: -1", Left

12. For each residential lot: Each lot is required to retain all storm water on site (except for the portion of driveway that drains directly to the street) during and after construction. This can be accomplished by use of swales, retention areas, berms, planter beds, underground infiltration, etc. A grading plan showing retention areas may be required on a case-by-case basis.

**Formatted:** QuickFormat5, Line spacing: Exactly 9.7 pt, Tab stops: -1", Left

13. Inlets shall not be installed at location of existing or future driveway.

**Formatted:** QuickFormat5, Justified, Indent: Left: 1", Hanging: 0.5", Line spacing: Exactly 9.7 pt, Numbered + Level: 2 + Numbering Style: 1, 2, 3, ... + Start at: 1 + Alignment: Left + Aligned at: 1" + Indent at: 1.25", Tab stops: -1", Left

14. Type, size, capacity, and details for oil/water separator shall be shown on the drawings.

**Formatted:** QuickFormat5, Line spacing: Exactly 9.7 pt, Tab stops: -1", Left

**C. DRAINAGE ANALYSIS AND REPORT**

1. A drainage analysis shall be completed and a report shall be submitted for review and approval. The Drainage Analysis Report shall include the following information:

**Formatted:** QuickFormat5, Justified, Indent: Left: 1", Hanging: 0.5", Line spacing: Exactly 9.7 pt, Numbered + Level: 2 + Numbering Style: 1, 2, 3, ... + Start at: 1 + Alignment: Left + Aligned at: 1" + Indent at: 1.25", Tab stops: -1", Left

a) Summary of Low Impact Development (LID) analysis where required (see LID section).

**Formatted:** QuickFormat5, Line spacing: Exactly 9.7 pt, Tab stops: -1", Left

b) Overall description of proposed drainage system (LID techniques, detention/retention, water quality mitigation, connection to existing storm drain system, receiving system or waters, etc.).

**Formatted:** QuickFormat5, Justified, Indent: Left: 1", Hanging: 0.5", Line spacing: Exactly 9.7 pt, Numbered + Level: 2 + Numbering Style: 1, 2, 3, ... + Start at: 1 + Alignment: Left + Aligned at: 1" + Indent at: 1.25", Tab stops: -1", Left

c) Summary of hydrologic and hydraulic analysis completed, describing methods used and calculations performed.

**Formatted:** QuickFormat5, Line spacing: Exactly 9.7 pt, Tab stops: -1", Left

d) Calculations for design storm runoff flows, times of concentration, and capacity of proposed storm drain pipes, inlets, gutters, channels, and swales.

**Formatted:** QuickFormat5, Indent: Left: 1", Hanging: 0.5", Line spacing: Exactly 9.7 pt, Numbered + Level: 2 + Numbering Style: 1, 2, 3, ... + Start at: 1 + Alignment: Left + Aligned at: 1" + Indent at: 1.25", Tab stops: -1", Left

e) Calculations/model results for detention and retention including volume, discharge rate, restriction orifice size, percolation rates, etc. Note that a 2-inch diameter orifice is the smallest size required. If a 2-inch diameter orifice results in a discharge of more than 0.2 cfs/acre, it is permissible to consider the greater discharge rate in the calculation of storm water detention volume.

f) Demonstrate that the downstream storm drain system has capacity for the peak discharge flows in a 10-year, 3-hour storm event, from the proposed development.

g) Demonstrate that in a 100-year, 3-hour storm event, runoff flows will be safely conveyed to the street and will not flood structures. Provide calculations (flows in cfs) and drawings as necessary to demonstrate this. The storm water flow routing shall be shown on the design drawings. Additional separate drawings may be required to show off-site flow routing as needed.

**Formatted:** QuickFormat5, Line spacing: Exactly 9.7 pt, Tab stops: -1", Left

**D. LOW IMPACT DEVELOPMENT**

1. As part of the Jordan Valley Municipalities Permit, the City encourages a Low Impact Development (LID) approach, which includes the implementation of structural BMPs, where practicable, that infiltrate, evapotranspire, treat, and/or harvest and use storm water for the site to protect water quality.

**Formatted:** QuickFormat5, Indent: Left: 1", Hanging: 0.5", Line spacing: Exactly 9.7 pt, Numbered + Level: 2 + Numbering Style: 1, 2, 3, ... + Start at: 1 + Alignment: Left + Aligned at: 1" + Indent at: 1.25", Tab stops: -1", Left

2. All development that warrants compliance with the UCGP regulation, must include an LID analysis that meets the objective of mirroring the predevelopment hydrology. No LID limits are defined except designs must not negatively impact surrounding properties. The analysis must identify LID options considered and list the reasons why it will be incorporated or why the considered LIDs are not practical for the site use or conditions.

**Formatted:** QuickFormat5, Line spacing: Exactly 9.7 pt, Tab stops: -1", Left

3. Suggested LIDs include:

**Formatted:** QuickFormat5, Justified, Indent: Left: 1", Hanging: 0.5", Line spacing: Exactly 9.7 pt, Numbered + Level: 2 + Numbering Style: 1, 2, 3, ... + Start at: 1 + Alignment: Left + Aligned at: 1" + Indent at: 1.25", Tab stops: -1", Left

a) Minimize impervious area on the site.

**Formatted:** QuickFormat5, Line spacing: Exactly 9.7 pt, Tab stops: -1", Left

b) Preserve natural areas undisturbed.

**Formatted:** QuickFormat5, Justified, Indent: Left: 1", Hanging: 0.5", Line spacing: Exactly 9.7 pt, Numbered + Level: 2 + Numbering Style: 1, 2, 3, ... + Start at: 1 + Alignment: Left + Aligned at: 1" + Indent at: 1.25", Tab stops: -1", Left



**Sandy City Corporation - Prod. 12/18**

- ~~e) Reduce directly-connected impervious area, using landscaped areas to capture and store runoff (bio-swales, bio-retention, rain gardens, retention, and detention) from roof drains or drive/parking areas.~~
- ~~d) Avoid concentrated runoff by distributing water to rain gardens, bio-swales, or bio-retention areas to infiltrate or evapotranspire runoff and treat the runoff.~~
- ~~e) Pervious pavement or pavers in parking areas or sidewalks.~~
- ~~f) Rainwater harvesting.~~
- ~~g) In-line underground storage.~~
- ~~h) Slope dumpster enclosure pads towards landscaping.~~
- ~~4. LID design has few limits but the selected LID must be defined and maintained via the requirements of the Post-Construction Storm Water Maintenance Plan and Agreement.~~
- ~~5. For proposed infiltration methods, the Developer should submit a soils test report, stamped, signed and dated by a soils Consulting Engineer, indicating soil types and depths, ground water depth (should be minimum of 5 feet below retention pond bottom elevation) and soil permeability rate to demonstrate that infiltration is feasible for the development.~~
- ~~**E. CLASS V UNDERGROUND INJECTION CONTROL WELLS**~~
- ~~1. Class V Underground Injection Control (UIC) storm water wells are typically shallow disposal wells designed to place rain water or melted snow below the land surface. Based on the UIC definitions in UAC R317-7-2, storm water controls that qualify as UIC wells include but are not limited to:~~
  - ~~a) Drywells and drill holes.~~
  - ~~b) Infiltration galleries.~~
  - ~~c) Commercially manufactured storm water infiltration devices (such as Storm Tech).~~
  - ~~d) Seepage pits & improved sinkholes.~~
- ~~2. Class V UIC wells shall be registered with the Utah State Division of Environmental Quality (DEQ). The "Utah Underground Injection Control Program Inventory Information" form must be submitted to DEQ and provide confirmation of receipt by DEQ.~~
- ~~**F. SUMPS**~~
- ~~1. If there are no usable storm drain facilities in the area, retention of storm water runoff may be required. Generally, sumps are not permitted in primary recharge zone, according to Sandy City Drinking Water Source Protection ordinance.~~
- ~~2. The Developer should contact the reviewing Engineer for Sandy City Public Utilities, to request a letter of approval for the sump. It is recommended that the reviewing Engineer for Sandy City Public Utilities, be contacted immediately to review this issue. Sumps are typically not allowed in ground water recharge zones.~~
- ~~3. The permeability rate of the soil may be used as a discharge rate.~~
- ~~4. Any existing sump must be replaced with a new sump, or it must be shown and accepted that the existing sump is adequate.~~
- ~~5. The Developer should submit plans and details of the sump design. If gravel is used in the sump, 1 ½ – 2-inch (min.) gravel should be specified, with a maximum void ratio of 40%.~~

**Formatted:** QuickFormat5, Line spacing: Exactly 9.7 pt, Tab stops: -1", Left

**Formatted:** QuickFormat5, Indent: Left: 1", Hanging: 0.5", Line spacing: Exactly 9.7 pt, Numbered + Level: 2 + Numbering Style: 1, 2, 3, ... + Start at: 1 + Alignment: Left + Aligned at: 1" + Indent at: 1.25", Tab stops: -1", Left

**Formatted:** QuickFormat5, Line spacing: Exactly 9.7 pt, Tab stops: -1", Left

**Formatted:** QuickFormat5, Justified, Indent: Left: 1", Hanging: 0.5", Line spacing: Exactly 9.7 pt, Numbered + Level: 2 + Numbering Style: 1, 2, 3, ... + Start at: 1 + Alignment: Left + Aligned at: 1" + Indent at: 1.25", Tab stops: -1", Left

**Formatted:** QuickFormat5, Line spacing: Exactly 9.7 pt, Tab stops: -1", Left

**Formatted:** QuickFormat5, Indent: Left: 1", Hanging: 0.5", Line spacing: Exactly 9.7 pt, Numbered + Level: 2 + Numbering Style: 1, 2, 3, ... + Start at: 1 + Alignment: Left + Aligned at: 1" + Indent at: 1.25", Tab stops: -1", Left

**Formatted:** QuickFormat5, Line spacing: Exactly 9.7 pt, Tab stops: -1", Left

**Formatted:** QuickFormat5, Indent: Left: 1", Hanging: 0.5", Line spacing: Exactly 9.7 pt, Numbered + Level: 2 + Numbering Style: 1, 2, 3, ... + Start at: 1 + Alignment: Left + Aligned at: 1" + Indent at: 1.25", Tab stops: -1", Left

**Formatted:** QuickFormat5, Line spacing: Exactly 9.7 pt, Tab stops: -1", Left

**Formatted:** QuickFormat5, Indent: Left: 1", Hanging: 0.5", Line spacing: Exactly 9.7 pt, Numbered + Level: 2 + Numbering Style: 1, 2, 3, ... + Start at: 1 + Alignment: Left + Aligned at: 1" + Indent at: 1.25", Tab stops: -1", Left

**Formatted:** QuickFormat5, Line spacing: Exactly 9.7 pt, Tab stops: -1", Left

**Formatted:** QuickFormat5, Justified, Indent: Left: 1", Hanging: 0.5", Line spacing: Exactly 9.7 pt, Numbered + Level: 2 + Numbering Style: 1, 2, 3, ... + Start at: 1 + Alignment: Left + Aligned at: 1" + Indent at: 1.25", Tab stops: -1", Left

**Formatted:** QuickFormat5, Line spacing: Exactly 9.7 pt, Tab stops: -1", Left

**Formatted:** QuickFormat5, Justified, Indent: Left: 1", Hanging: 0.5", Line spacing: Exactly 9.7 pt, Numbered + Level: 2 + Numbering Style: 1, 2, 3, ... + Start at: 1 + Alignment: Left + Aligned at: 1" + Indent at: 1.25", Tab stops: -1", Left

**Formatted:** QuickFormat5, Line spacing: Exactly 9.7 pt, Tab stops: -1", Left

**Formatted:** QuickFormat5, Justified, Indent: Left: 1", Hanging: 0.5", Line spacing: Exactly 9.7 pt, Numbered + Level: 2 + Numbering Style: 1, 2, 3, ... + Start at: 1 + Alignment: Left + Aligned at: 1" + Indent at: 1.25", Tab stops: -1", Left

**Formatted:** QuickFormat5, Line spacing: Exactly 9.7 pt, Tab stops: -1", Left

**Formatted** ...

**Sandy City Corporation - Prod. 12/18**

**G. STORM WATER TREATMENT**

- ~~1. Prior to discharging storm water, it must be treated to reduce illicit discharges of sediments, oils, floatables and other pollutants. The treatment method must be approved by the City.~~
- ~~2. An oil water separator is required prior to discharge into any storm drain system that meets the following requirements.~~
  - ~~a) Three-chamber structure that meets HS-20 loading requirements.~~
  - ~~b) Designed so that the flows during the first 15 minutes of a 2-year, 1-hour storm will be allowed to stay in the detention/holding area of the separator for a time sufficient for 98% of the oil to rise above the outlet side of the central chamber.~~
  - ~~c) Includes a bypass for higher flows beyond the first 15 minutes of a 2-year, 1-hour storm to flow outside the separator without flushing the separator out.~~
  - ~~d) Designed with the following requirements (based on a simple, three-chamber oil/water separator):~~
    - ~~i. Oil specific gravity of 0.89.~~
    - ~~ii. Runoff water temperature of 50 degrees Fahrenheit.~~
    - ~~iii. Oil entering the separator has a concentration of 400 p.p.m.~~
    - ~~iv. Allowable concentration leaving the separator has a concentration of 10 p.p.m. (98%).~~
    - ~~v. Rainfall intensities used in the Storm Water Master Plan and adjusted according to elevation.~~
    - ~~vi. Terminal rise rate of 0.00055 ft/s.~~
  - ~~e) If the Developer desires to use a different product, technical information about the proposed product shall be submitted with all design information demonstrating that the product meets or exceeds the requirements specified above for an oil/water separator.~~

**2. IRRIGATION**

1. The Developer is required to provide a continuance of appropriate irrigation facilities for irrigation water users who historically have relied upon facilities on or crossing through the project site, including any needs that may become apparent during or after construction of the project. The design and construction of any irrigation facilities should be approved by any down-stream users, the irrigation company, and by Sandy City Public Utilities.
2. If there is no irrigation easements of record for an existing irrigation facility, an easement must be provided. Contact the irrigation facility owner to determine the required width.
3. It is required that all existing irrigation canal, ditch or pipe that is maintained by Sandy City be replaced with RCP. Irrigation pipes shall be sized to handle the existing flow requirements. Sandy City Public Utilities shall be contacted for information regarding these requirements.
4. There may be existing irrigation facilities which potentially could be abandoned. It is the responsibility of the Developer to complete any research necessary to make that determination.

**Formatted:** QuickFormat5, Line spacing: Exactly 9.7 pt, Tab stops: -1", Left

**Formatted:** QuickFormat5, Indent: Left: 1", Hanging: 0.5", Line spacing: Exactly 9.7 pt, Numbered + Level: 2 + Numbering Style: 1, 2, 3, ... + Start at: 1 + Alignment: Left + Aligned at: 1" + Indent at: 1.25", Tab stops: -1", Left

**Formatted:** QuickFormat5, Line spacing: Exactly 9.7 pt, Tab stops: -1", Left

**Formatted:** QuickFormat5, Justified, Indent: Left: 1", Hanging: 0.5", Line spacing: Exactly 9.7 pt, Numbered + Level: 2 + Numbering Style: 1, 2, 3, ... + Start at: 1 + Alignment: Left + Aligned at: 1" + Indent at: 1.25", Tab stops: -1", Left

5. Irrigation facility design drawings shall be submitted to Sandy City and the ditch owners/users for approval. A letter must be obtained from the irrigation facility owner(s) and user(s) (approving the plans) and submitted to Sandy City Public Utilities.

4.D. STORM WATER POLLUTION PREVENTION PLAN

1. A Storm Water Pollution Prevention Plan (SWPPP) shall be prepared and submitted with plans for approval by Public Utilities Department. This plan shall meet the requirements of Jordan Valley Municipalities Permit UTS000001, Utah Construction General Permit (UCGP) UTRC00000, and/or Common Plan Permit UTRH00000 where required. A ~~hard~~ copy of the SWPPP ~~is required for the first submittal and resubmittals may~~ shall be submitted electronically.

Formatted: Indent: Left: 1.5", No bullets or numbering

2. A SWPPP is required to be prepared and submitted for review and approval by the Public Utilities Department for the following cases:

Formatted: List Paragraph, Left, No bullets or numbering

a.) Land disturbing activity that generally disturbs one or more acres of land;

Formatted: Indent: Left: 2", No bullets or numbering

b.) Land disturbing activity of less than one acre of land if such activity is part of a larger common plan of development that affects one or more acres of land;

Formatted: List Paragraph, Left, No bullets or numbering

c.) Land disturbing of less than one acre of land, and, if in the discretion of the Public Utilities Director, such activity poses a unique threat to water quality, air quality, or public health safety;

Formatted: List Paragraph, Left, No bullets or numbering

d.) The creation and use of borrow pits;

Formatted: List Paragraph, Left, No bullets or numbering

e.) Development of a single-family home;

Formatted: List Paragraph, Left, No bullets or numbering

f.) Processing of earthen materials such as topsoil and gravel screening;

Formatted: List Paragraph, Left, No bullets or numbering

g.) Construction of parking lots;

Formatted: List Paragraph, Left, No bullets or numbering

h.) Demolitions.

Formatted: No bullets or numbering

3. If a SWPPP and/or NOI are required for a project, they must be submitted and approved by the Public Utilities Department prior to obtaining any of the following Sandy City permits or approvals:

Formatted: No bullets or numbering

a.) Grading permit.

Formatted: Indent: Left: 2", No bullets or numbering

b.) Subdivision plan approval (residential).

Formatted: List Paragraph, Left, No bullets or numbering

c.) Site plan approval (commercial).

Formatted: List Paragraph, Left, No bullets or numbering

d.) Building permit.

Formatted: List Paragraph, Left, No bullets or numbering

e.) Road cut permit.

Formatted: No bullets or numbering

4.f.) Floodplain Development Permit.

Formatted: Indent: Left: 1.5", Hanging: 0.5"

2.4. For all projects that warrant compliance with the UCGP or Common Plan Permit

regulation, a Notice of Intent (NOI) for permit coverage must be obtained from Utah State Division of Water Quality under the respective permit. These projects are required to use the most current State templates, in order to satisfy state regulation. The templates are also necessary to create an environment of manageability and equality among all permit applicants.

5. For projects that warrant compliance with the UCGP and Common Plan Permit, the SWPPP shall be managed via an internet-based management system per the Land Development Code (LDC) Chapters 15A-15, 15A-20, and 15A-23. A hard copy of all SWPPPs shall be submitted to Sandy City Public Utilities for review.

a) The online SWPPP management system shall meet audit requirements of the State of Utah.

b) The online SWPPP management system shall be reviewed and approved by the Public Utilities Department prior to approval of the SWPPP and issuance of the permits or approvals listed in the section above.

c) Reports and data shall be made available upon request.

3-d) City Staff shall have viewing access rights.

4-6. There are four categories of SWPPPs based on size and type of development and construction (see below):

a) UPDES ~~Construction General Permit (CGP)~~ SWPPP.

i. All commercial and industrial projects regardless of size.

ii. Demolition of commercial or industrial structures.

iii. Projects disturbing an area equal to or greater than 1 acre.

iii-iv. Temporary use of borrow pits (including processing and screening of topsoil and gravel).

iv-v. New parking lot less than 1 acre ~~that includes any of the following: storm drains, retention/detention ponds, inlets.~~

b) UPDES Common Plan SWPPP.

i. Residential development projects that disturb less than 1 acre including the following:

a. Individual lot.

b. Individual lot that is part of a larger common plan of development.

~~c. Multiple lot subdivision.~~

c) ~~Linear Project~~ Small Excavation Project Disturbing Less Than 1 Acre SWPPP.

i. This SWPPP may be used at the discretion of the City. Contractor

Formatted: List Paragraph, Left, No bullets or numbering

Formatted: Indent: Left: 2", No bullets or numbering

Formatted: List Paragraph, Left, No bullets or numbering

Formatted: List Paragraph, Left, No bullets or numbering

Formatted: Indent: Left: 1.5", Hanging: 0.5"

Formatted: Indent: Left: 2.5", No bullets or numbering



may be directed to use the CGP or Common Plan SWPPP for this category depending on the size and complexity of the project.

- d) Miscellaneous Small Project SWPPP.
  - i. Miscellaneous small project include but are not limited to the following:
    - a. Swimming pools.
    - b. New or replacement driveway.
    - c. ~~House~~Building addition.
    - e-d. Remodel.
    - d-e. New garage.
    - e-f. Overlay or remove and replace parking lot (does not include regrading asphalt projects).
    - f-g. Residential demolition.
    - g-h. Sidewalk.
    - h-i. Curb and gutter.
    - i. Drive approach.
    - i-k. Work in the park strip.
    - j-l. ~~Other W~~ork in the public right-of-way that does not meet the criteria of the other three SWPPP categories.

Formatted: List Paragraph, Left, No bullets or numbering

Formatted: List Paragraph, Left, No bullets or numbering

J-E. CONSTRUCTION BEST MANAGEMENT PRACTICES

1. The City adopts as its Best Management Practice (BMP) manuals for construction, the following publications:
  - a) Salt Lake County Public Works Department "Guidance Document for Storm Water Management".
  - b) Salt Lake Valley Health Department Storm Water Regulations.
  - c) Jordan River Commission "Best Practices for Riverfront Communities".
  - d) Utah DEQ's Top Ten BMPs for Construction Sites.
  - e) EPA's Construction Site Storm Water Runoff Control website.
2. These manuals include lists of acceptable BMPs and specific design performance criteria and operation and maintenance requirements for each storm water practice. The manuals may be updated and expanded from time to time, at the discretion of the governing body of the City, based on improvements in engineering, science, monitory and local maintenance experience.

K.F. CONSTRUCTION

1. Construction work shall be conducted in accordance with UPDES, ~~and UCGP,~~ and Common Plan requirements.
2. For projects that warrant compliance with the UCGP or Common Plan Permit, inspections shall be completed per the requirements of the UCGP or Common Plan Permit. All inspections shall be documented and made available via the online SWPPP management system.
3. Regular review of the online SWPPP management system and inspections may be completed by Sandy City Public Utilities to confirm that construction work is being performed in accordance with UCGP or Common Plan Permit requirements. Review and inspection reports completed by Sandy City Public Utilities will be provided to the Contractor which are to be posted to the online SWPPP management system. All identified violations are to be addressed and documented on the online SWPPP management system.
- 3.4. SWPPP requirements specific to Sandy City are found in Section 02010 – Storm Water Pollution Prevention Plan Requirements.

Formatted: List Paragraph, Left, No bullets or numbering

L.G. POST-CONSTRUCTION STORM WATER MAINTENANCE AGREEMENT

1. The purpose of the Post-Construction Storm Water Maintenance Plan and Agreement (PCMA) is to control storm water runoff and reduce pollutants in storm water runoff after construction is complete and the developed site is in operation. This is achieved by accomplishing the following:
  - a) Controlling erosion.
  - b) Controlling discharge of sediment into storm drain facilities or off-site.
  - c) Preventing illicit discharges into on-site soils, storm drainage facilities or off-site.
  - d) Prevention of debris and garbage from entering the storm drain system.
2. A PCMA is required for all privately-owned or maintained facilities that warrant compliance with the UCGP regulation.
3. A Post-Construction Storm Water Maintenance Plan must be prepared and submitted with the plans for approval of the PCMA. The plan shall be contained on a plan sheet(s) of its own, rather than being a part of another plan sheet, and is to contain at least the following:
  - a) The site plan, ~~including vicinity map,~~ proposed contours, permanent storm water features, and landscaping.
  - b) BMPs to accomplish the purpose of the plan. Examples of appropriate BMPs may include those addressing operation and maintenance of storm drainage quality control facilities, operation and maintenance of storm water discharge control facilities, maintenance of landscaping, good housekeeping practices, etc.

**Sandy City Corporation - Prod. 12/18**

- c) Showing the following for each BMP specified:
  - i. Location and extent of specified BMPs, as appropriate.
  - ii. Detailed schedule of execution for each specified BMP, in terms of starting time, duration, frequency, etc., as appropriate.
  - iii. Any information in addition to or different from that shown on the BMP fact sheets as necessary to employ the BMPs on the site.
- d) ~~For final approval, the Project Owner must submit the original signed and notarized PCMA to Public Utilities. The using the most current Sandy City Agreement template shall be used.~~
- e) ~~Once the project has received final approval, Once the project is complete and ready for 90% bond release, Sandy City will record the PCMA at the Salt Lake County Recorder's Office per the requirements in the LDC. If there are changes to the storm drain system during construction, the PCMA will need to be modified and recorded.~~

**M.H. NOTICE OF TERMINATION**

- 1. Once the site is stabilized, the site operator must submit a Notice of Termination (NOT) to the Utah State Division of Water Quality and to Sandy City Public Utilities, for projects that warrant compliance with the UCGP and Common Plan Permit regulation. Once the NOT is received by Sandy City Public Utilities, a final inspection will be performed.

**7.067 STREET LIGHTS**

**A. GENERAL**

- 1. As per Sandy City Ordinance 01-8, the Developer may be required to install a residential or arterial streetlight along their frontage per Sandy City Standards and Specifications. Locations of the streetlight will be determined during the Preliminary Review.
- ~~1-2. Existing streetlights that are found to not meet current City standards and specifications are required to be upgraded per current City standards and specifications.~~
- 2-3. The Developer is required to grant to the City a minimum of 15-foot wide electrical easement (7.5-feet each side of pipe) for all conduit and junction box that was installed on private property, that will be maintained by the City. Easement shall be on a signed standard easement form (template is available from Sandy City Public Utilities) or called out on the plat. Easements shall be completed and submitted to the City after all ~~waterlines~~streetlights have been installed and before the 90% bond release. Structures, buildings, and other utilities shall not be installed within the ~~waterlines~~streetlight easement.

Formatted: Indent: Left: 1.5", No bullets or numbering  
Formatted: List Paragraph  
Formatted: Font: (Default) Arial

**7.078 UTILITIES**

**A. GENERAL**

Sandy City Corporation - Prod. 12/18

1. Residential:
  - a) To comply with Sandy City Ordinance 15A-21-19A, All utilities which will serve the parcel being subdivided shall be buried beneath the surface of the ground and shall be located within the easements provided for such use or within the streets at a location to be determined by the City.
2. Commercial:
  - a) To comply with Sandy City Ordinance 15A-23-12, all utility lines shall be placed underground in designated easements. No pipe, conduit, cable, line for water, gas, sewage, drainage, steam, electricity, or any other energy or service shall be installed on a permanent basis above ground. However, back flow devices have to be installed above ground. Therefore, no pole or other support structure shall be erected, altered, or replaced upon any lot (outside of any building) above the surface of the ground except for hoses, movable pipes used for irrigation or other purpose during construction.
  - b) Each Contractor and Developer/Project Owner shall be responsible to know the whereabouts of all underground utilities. Protection of such utilities shall also be their responsibility. Prior to construction, contact must be made with "Blue Stakes" to identify underground utility lines.
  - c) Where overhead poles exist, service lines to new developments must be placed underground from the nearest overhead service pole.
  - d) All utility lines associated with the pre-existing utility pole(s) shall be placed underground across the frontage of the development.
  - e) All utility boxes, e.g., transformers, switch gear, telephone, cable tv, back flow preventers, etc., shall be shown on the site plan and utility plan and shall be placed a minimum of 5 feet from any sidewalk or parking lot curbing. Said utility boxes shall not be located within any required traffic sight triangle(s), as determined by the City Transportation Engineer and shall be screened from view with appropriate landscaping or architectural elements compatible in material and color with the primary structure. Each box shall be shown in its exact location and shall be noted with its exact height, width, and length. (Ord 09-01, Amended 3-5-2009)
  - f) The Developer must contact Rocky Mountain Power for installation service, charges, permits, and related items that they will require for developments that are within Sandy City's borders.

| 7.089 WATER EFFICIENT LANDSCAPE

A. GENERAL

1. A Landscape Plan Documentation Package shall be submitted to and approved by the Sandy City Public Utilities Department as part of the final review process. The Landscape Plan Documentation Package shall consist of the following items:
  - a) Planting Plan. A detailed Planting Plan shall be drawn at a scale that clearly identifies the following:



Sandy City Corporation - Prod. 12/18

- i. Location of all plant materials, a legend with botanical and common names, and size of plant materials.
  - ii. Property lines and street names.
  - iii. Existing and proposed buildings, walls, fences, light poles, utilities, paved areas and other site improvements.
  - iv. Existing trees and plant materials to be removed or retained.
  - v. Designation of Landscape Zones.
- b) Irrigation Plan. Irrigation plans shall be prepared and stamped by a licensed landscape architect or a licensed landscape designer. A detailed Irrigation Plan shall be drawn at the same scale as the planting plan and shall contain the following information:
- i. Layout of the irrigation system and a legend summarizing the type and size of all components of the system, including manufacturer name and model numbers.
  - ii. Static water pressure in pounds per square inch (psi) at the point of connection to the public water supply.
  - iii. Flow rate in gallons per minute and design operating pressure in psi for each valve and precipitation rate in inches per hour for each valve with sprinklers.
  - iv. Location and Size of Water Meter, which shall be used exclusively for landscape purposes.
  - v. Location of the point of connection, sprinkler heads, backflow prevention device, main and lateral irrigation lines, quick couplers, irrigation controller and moisture sensor overriding device.
  - vi. Size and flow rate of each irrigation zone, valve and sprinkler head; Static water pressure at point of connection; and Symbols, brand name and model number for each sprinkler head and irrigation device.
- c) Landscape Water Allowance. The annual Landscape Water Allowance shall be calculated using the following equation:
- $$\text{Landscape Water Allowance} = \text{ETO} \times 1.0 \times 0.62 \times A$$
- Where Landscape Water Allowance is in gallons per growing season
- ETO = Reference Evapotranspiration in inches per growing season  
1.0 = ETO adjustment factor, 100% of turf grass ETO (growing season adjustment factor)  
0.62 = conversion factor  
A = total Irrigated Landscape Area in square feet
- d) Irrigation Schedule. A monthly Irrigation Schedule shall be prepared that

Sandy City Corporation - Prod. 12/18

covers the initial 90-day plant establishment period and the typical long-term use period. This schedule shall consist of a table with the following information for each valve:

- i. Plant type (for example, turf, trees, low water use plants).
- ii. Irrigation type (for example, sprinklers, drip, bubblers).
- iii. Flow rate in gallons per minute.
- iv. Precipitation rate in inches per hour (sprinklers only).
- v. Run times in minutes per day.
- vi. Number of water days per week.
- vii. Cycle time to avoid runoff.

B. LANDSCAPE DESIGN

1. Design landscape according to the following criteria - refer to Ordinance 15-41 for additional information:
  - a) Plants are well-suited to microclimate and soil conditions at site, are relatively free from pests and diseases, and are generally easy to maintain.
  - b) Water-Conserving plants are used on slopes exceeding 30 percent.
  - c) Minimum four-inches of mulch on all irrigated non-turf areas. If rock mulch, minimum is three-inches.

C. IRRIGATION DESIGN

1. Design irrigation according to the following criteria - refer to Ordinance 15-41 for additional information:
  - a) Landscape Water Meter and backflow prevention assembly that are in compliance with state code shall be installed separate from the water meter installed for indoor use. The size of the meter shall be determined based on the irrigation demand. This meter must be installed after the main meter and shall remain within the Sandy City Easement. The Developer shall supply the landscape meter and materials. Show on the utility plan and landscape plan.
  - b) Pressure regulator provided where water pressure exceeds 80 psi operating pressure for the sprinkler heads or where significant variation in water pressure will occur.
  - c) Automatic controller provided with multiple program and repeat cycle capabilities, automatic rain shut-off device, and a flexible calendar program.
  - d) On slopes over 30 percent, irrigation system shall consist of Drip Emitters, Bubblers or Sprinklers with a maximum Precipitation Rate of 0.85 inches

Sandy City Corporation - Prod. 12/18

per hour and adjusted sprinkler cycle times to eliminate runoff.

- e) Each valve irrigates area with similar site, slope, and soil conditions and plants with similar water needs. Turf and non-turf areas irrigated on separate valves.
- f) Drip Emitters or a Bubbler shall be provided for each tree where practicable. Bubblers shall not exceed 1.5 gallons per minute per device. Bubblers for trees shall be on a separate valve unless specifically exempted by Sandy City Public Utilities due to the limited number of trees on the project. Filters and end flush valves shall be provided as necessary.
- g) Sprinklers have matched Precipitation Rate within each valve.
- h) Check valves specified where low-head drainage will occur due to elevation differences. Pressure compensating valves and sprinklers shall be required where a significant variation in water pressure will occur within the irrigation system due to the limited number of trees.
- i) Irrigation zones with overhead spray or stream sprinklers shall be designed to operate between 6:00 pm and 10:00 am to reduce water loss from wind and evaporation. This would exclude drip or bubbler zones.
- j) Following Construction and prior to release of the secondary bond guarantee posted for the project, a Water Use Efficiency Review will be conducted by a Landscape Irrigation Auditor. The auditor shall be independent of the Contractor, design firm, and Developer/Project Owner. The water performance audit will verify that the irrigation system complies with the minimum standards required by Sandy City ordinance. The minimum efficiency required for the irrigation system is 60% for distribution efficiency for all fixed spray system and 70% distribution efficiency for all rotor systems. The auditor shall furnish a certificate to the City, designer, installer and Developer/Project Owner certifying compliance with the minimum distribution requirements. Compliance with this provision is required before the City will release the bond for this project.

**10-YEAR STORM EVENT: RAINFALL INTENSITIES (INCHES PER HOUR) ADJUSTED FOR ELEVATION**

ADJUST. FACTOR	0.94	0.96	0.98	1	1.03	1.06	1.09	1.12	1.15	1.18	1.2	1.19	1.17	1.16	1.14	1.13	1.11	1.1
ELEV.	4300	4400	4500	4600	4700	4800	4900	5000	5100	5200	5300	5400	5500	5600	5700	5800	5900	6000

TIME (MIN.)	STANDARD INTENSITY	INTENSITY INCHES PER HOUR (ADJUSTED)																	
5	3.72	3.57	3.57	3.65	3.72	3.83	3.94	4.05	4.17	4.28	4.39	4.46	4.43	4.35	4.32	4.24	4.20	4.13	4.09
15	2.28	2.14	2.19	2.23	2.28	2.35	2.42	2.49	2.55	2.62	2.69	2.74	2.71	2.67	2.64	2.60	2.58	2.53	2.51
30	1.44	1.35	1.38	1.41	1.44	1.48	1.53	1.57	1.61	1.66	1.70	1.73	1.71	1.68	1.67	1.64	1.63	1.60	1.58
45	1.15	1.08	1.10	1.13	1.15	1.18	1.22	1.25	1.29	1.32	1.36	1.38	1.37	1.35	1.33	1.31	1.30	1.28	1.27
60	0.93	0.87	0.89	0.91	0.93	0.96	0.99	1.01	1.04	1.07	1.10	1.12	1.11	1.09	1.08	1.06	1.05	1.03	1.02
90	0.69	0.65	0.66	0.68	0.69	0.71	0.73	0.75	0.77	0.79	0.81	0.83	0.82	0.81	0.80	0.79	0.78	0.77	0.76
120	0.55	0.52	0.53	0.54	0.55	0.57	0.58	0.60	0.62	0.63	0.65	0.66	0.65	0.64	0.64	0.63	0.62	0.61	0.61
180	0.40	0.38	0.38	0.39	0.40	0.41	0.42	0.44	0.45	0.46	0.47	0.48	0.48	0.47	0.46	0.46	0.45	0.44	0.44
360	0.25	0.24	0.24	0.25	0.25	0.26	0.27	0.27	0.28	0.29	0.30	0.30	0.30	0.29	0.29	0.29	0.28	0.28	0.28
720	0.15	0.14	0.14	0.15	0.15	0.15	0.16	0.16	0.17	0.17	0.18	0.18	0.18	0.18	0.17	0.17	0.17	0.17	0.17
1440	0.09	0.08	0.09	0.09	0.09	0.10	0.10	0.10	0.10	0.11	0.11	0.11	0.11	0.11	0.10	0.10	0.10	0.10	0.10

**25-YEAR STORM EVENT: RAINFALL INTENSITIES (INCHES PER HOUR) ADJUSTED FOR ELEVATION**

ADJUST. FACTOR	0.92	0.95	0.98	1	1.04	1.08	1.12	1.16	1.19	1.22	1.25	1.23	1.21	1.18	1.16	1.14	1.12	1.1
ELEV.	4300	4400	4500	4600	4700	4800	4900	5000	5100	5200	5300	5400	5500	5600	5700	5800	5900	6000

TIME (MIN.)	STANDARD INTENSITY	INTENSITY INCHES PER HOUR (ADJUSTED)																	
5	4.92	4.53	4.67	4.82	4.92	5.12	5.31	5.51	5.71	5.85	6.00	6.15	6.05	5.95	5.81	5.71	5.61	5.51	5.41
15	3.04	2.80	2.89	2.98	3.04	3.16	3.28	3.40	3.53	3.62	3.71	3.80	3.74	3.68	3.59	3.53	3.47	3.40	3.34
30	1.92	1.77	1.82	1.88	1.92	2.00	2.07	2.15	2.23	2.28	2.34	2.40	2.36	2.32	2.27	2.23	2.19	2.15	2.11
45	1.50	1.38	1.43	1.47	1.50	1.56	1.62	1.68	1.74	1.79	1.83	1.88	1.85	1.82	1.77	1.74	1.71	1.68	1.65
60	1.25	1.15	1.19	1.23	1.25	1.30	1.35	1.40	1.45	1.49	1.53	1.56	1.54	1.51	1.48	1.45	1.43	1.40	1.38
90	0.9	0.83	0.86	0.88	0.90	0.94	0.97	1.01	1.04	1.07	1.10	1.13	1.11	1.09	1.06	1.04	1.03	1.01	0.99
120	0.72	0.66	0.68	0.71	0.72	0.75	0.78	0.81	0.84	0.86	0.88	0.90	0.89	0.87	0.85	0.84	0.82	0.81	0.79
180	0.54	0.50	0.51	0.53	0.54	0.56	0.58	0.60	0.63	0.64	0.66	0.68	0.66	0.65	0.64	0.63	0.62	0.60	0.59
360	0.33	0.30	0.31	0.32	0.33	0.34	0.36	0.37	0.38	0.39	0.40	0.41	0.41	0.40	0.39	0.38	0.38	0.37	0.36
720	0.19	0.17	0.18	0.19	0.19	0.20	0.21	0.21	0.22	0.23	0.23	0.24	0.23	0.23	0.22	0.22	0.22	0.21	0.21
1440	0.12	0.11	0.11	0.12	0.12	0.12	0.13	0.13	0.14	0.14	0.15	0.15	0.15	0.15	0.14	0.14	0.14	0.13	0.13

**100-YEAR STORM EVENT: RAINFALL INTENSITIES (INCHES PER HOUR) ADJUSTED FOR ELEVATION**

ADJUST. FACTOR FOR TIMES: 5-180 MINUTES	0.90	0.933	0.966	1	1.043	1.086	1.129	1.171	1.214	1.257	1.3	1.214	1.129	1.043	0.957	0.871	0.786	0.7
ELEV.	4300	4400	4500	4600	4700	4800	4900	5000	5100	5200	5300	5400	5500	5600	5700	5800	5900	6000

TIME (MIN.)	STANDARD INTENSITY	INTENSITY INCHES PER HOUR (ADJUSTED)																	
5	6.96	6.26	6.49	6.72	6.96	7.26	7.56	7.86	8.15	8.45	8.75	9.05	8.45	7.86	7.26	6.66	6.06	5.47	4.87
15	4.32	3.89	4.03	4.17	4.32	4.51	4.69	4.88	5.06	5.24	5.43	5.62	5.24	4.88	4.51	4.13	3.76	3.40	3.02
30	2.72	2.45	2.54	2.63	2.72	2.84	2.95	3.07	3.19	3.30	3.42	3.54	3.30	3.07	2.84	2.60	2.37	2.14	1.90
45	2.10	1.89	1.96	2.03	2.10	2.19	2.28	2.37	2.46	2.55	2.64	2.73	2.55	2.37	2.19	2.01	1.83	1.65	1.47
60	1.78	1.60	1.66	1.72	1.78	1.86	1.93	2.01	2.08	2.16	2.24	2.31	2.16	2.01	1.86	1.70	1.55	1.40	1.25
90	1.40	1.26	1.31	1.35	1.40	1.46	1.52	1.58	1.64	1.70	1.76	1.82	1.70	1.58	1.46	1.34	1.22	1.10	0.98
120	1.03	0.93	0.96	0.99	1.03	1.07	1.12	1.16	1.21	1.25	1.29	1.34	1.25	1.16	1.07	0.99	0.90	0.81	0.72
180	0.77	0.69	0.72	0.74	0.77	0.80	0.84	0.87	0.90	0.93	0.97	1.00	0.93	0.87	0.80	0.74	0.67	0.61	0.54
360	0.47	0.48	0.48	0.49	0.49	0.50	0.50	0.51	0.51	0.52	0.52	0.53	0.53	0.54	0.54	0.55	0.55	0.56	0.56
720	0.28	0.29	0.29	0.29	0.29	0.30	0.30	0.30	0.31	0.31	0.31	0.31	0.32	0.32	0.32	0.32	0.33	0.33	0.33
1440	0.16	0.16	0.16	0.17	0.17	0.17	0.17	0.17	0.17	0.18	0.18	0.18	0.18	0.18	0.18	0.19	0.19	0.19	0.19
2880	0.10	0.10	0.10	0.10	0.11	0.11	0.11	0.11	0.11	0.11	0.11	0.11	0.11	0.11	0.12	0.12	0.12	0.12	0.12
4320	0.07	0.07	0.07	0.07	0.07	0.07	0.07	0.08	0.08	0.08	0.08	0.08	0.08	0.08	0.08	0.08	0.08	0.08	0.08

ADJUST. FACTOR FOR TIMES: 360-4320 MINUTES	1.02	1.03	1.04	1.05	1.06	1.07	1.08	1.09	1.1	1.107	1.118	1.13	1.14	1.15	1.16	1.17	1.184	1.195
--	------	------	------	------	------	------	------	------	-----	-------	-------	------	------	------	------	------	-------	-------



## PART 7.0 B STORM WATER DESIGN CRITERIA

### 7.01 INTRODUCTION

- A. Purpose – This storm water design criteria establishes minimum storm water management requirements and controls to protect the general health, safety, and welfare of the public residing within the City, while protecting water resources of the City and reducing the adverse impact of storm water runoff on receiving waters.
- B. References – Unless provided otherwise, the criteria and methods presented in the most recent versions of the following references shall be used in planning and design of each storm water system.
  - 1. “Manual of Standard Plans”, APWA Utah Chapter, current version.
  - 2. “Hydraulic Engineering Circular No. 22” (HEC-22), Third Edition FHWA (revised August 2013) HEC-22.  
<https://www.fhwa.dot.gov/engineering/hydraulics/pubs/10009/10009.pdf>
  - 3. “Urban Storm Drainage Criteria Manual” (USDCM) 2018, Urban Drainage and Flood Control District. <https://udfcd.org/criteria-manual>
  - 4. Sandy City LID Toolbox.
  - 5. “Development of Stormwater Low Impact Development Suitability Framework for Sandy City”.
  - 6. Sandy City Standard Specifications and Details.  
<https://www.sandy.utah.gov/departments/public-utilities/standard-specifications>.

### 7.02 DEFINITIONS

- A. “Base Flood Elevation” (BFE) – refers to the elevation of the flood having a one percent chance of being equaled or exceeded in any given year.
- B. “Best Management Practice” (BMP) – means a technique, process, activity, or structure used to reduce pollutant discharges in storm water. BMPs include source control practices (non-structural BMPs) and engineered structures designed to treat runoff. BMPs are most effective when used in combination and selected and designed based on site-specific characteristics.
- C. “Channel” – means a natural or artificial watercourse with a definite bed and banks that conveys continuously or periodically flowing water. Interchangeable terms include creek, drainageway, river, stream, swale, and watercourse.
- D. “Detention” – means the temporary storage of storm water runoff in a storm water management facility with the goals of controlling peak discharge rates and providing gravity settling of pollutants.
- E. “Detention Facility” – means a detention basin or alternative structure designed for the purpose of temporary storage of stream flow or surface runoff and gradual release of stored water at controlled rates.
- F. “Developer” – any individual or entity completing development, including Sandy City.
- G. “Development” – means any manmade change to improved or unimproved real estate, including, but not limited to, building or other structures, mining, dredging, filling, grading, paving, excavation, or drilling operations.
- H. “Freeboard” – is a factor of safety usually expressed in feet above a flood level for purposes of floodplain and flood control management. Freeboard compensates for the many unknown factors that could contribute to flood heights greater than the height calculated for the design flood.

- I. “Low Impact Development” (LID) – is a design methodology that mimics natural hydrology by increasing pervious surfaces and slowing down urban runoff, providing infiltration closer to the source, thus reducing the likelihood of contaminants getting introduced into the runoff.
- J. “Retention” – means the storage of storm runoff in a storm water management facility without release other than through infiltration and evaporation.
- K. “Runoff” – is water that travels across the land surface, or laterally through the ground near the land surface, and discharges to water bodies either directly or through a collection and conveyance system. Runoff includes storm water and water from other sources that travels across the land surface.
- L. “Return period” – is the reciprocal of probability of occurrence in any given year. For example, a 100-year event has a 1% probability of being equaled or exceeded in any given year.
- M. “Water Quality Volume” (WQV) – is the storm runoff from the 80<sup>th</sup> percentile storm. The design 80<sup>th</sup> percentile storm depth for Sandy City is 0.5 inches.

### 7.03 ABBREVIATIONS

- A. API (American Petroleum Institute)
- B. APWA (American Public Works Association)
- C. ASCE (American Society of Civil Engineers)
- D. ASTM (American Society for Testing and Materials)
- E. BFE (Base Flood Elevation)
- F. BMP (Best Management Practice)
- G. CFR (Code of Federal Regulations)
- H. cfs (cubic feet per second)
- I. CMP (Corrugated Metal Pipe)
- J. CN (Curve Number)
- K. CPI (Coalescing Plate Interceptor)
- L. CPOD (Common Plan of Development or Sale which Collectively Disturbs Land Greater than or Equal to One Acre)
- M. CSWMP (Comprehensive Storm Water Management Program)
- N. DEQ (Utah Department of Environmental Quality)
- O. DWQ (Utah Department of Environmental Quality Division of Water Quality)
- P. DWSP (Drinking Water Source Protection)
- Q. EGL (Energy Grade Line)

- R. EPA (U.S. Environmental Protection Agency)
- S. FEMA (Federal Emergency Management Agency)
- T. FHWA (Federal Highway Administration)
- U. FIRM (Flood Insurance Rate Map)
- V. FIS (Flood Insurance Study)
- W. FMP (Floodplain Management Program)
- X. fps (feet per second)
- Y. GI (Green Infrastructure)
- Z. HEC-HMS (The Army Corps of Engineers Hydrologic Engineering Center – Hydrologic Modeling System)
- AA. HDPE (High Density Polyethylene)
- BB. HGL (Hydraulic Grade Line)
- CC. hr (hour)
- DD. HUD (U.S. Department of Housing and Urban Development)
- EE. H:V (Horizontal to vertical ratio of a slope)
- FF. I.A. (Impervious Area)
- GG. in/hr (inches per hour)
- HH. incr. (increase)
- II. LID (Low Impact Development)
- JJ. MCM (Minimum Control Measure)
- KK. MS4 (Municipal Separate Storm Water System)
- LL. NOAA (National Oceanic and Atmospheric Administration)
- MM. NRCS (Natural Resources Conservation Service)
- NN. PVC (Polyvinyl Chloride)
- OO. RCP (Reinforced Concrete Pipe)
- PP. s.f. (square feet)
- QQ. SWAMP (Storm Water Asset Management Program)
- RR. SWMM (EPA Stormwater Management Model)
- SS. T.D. (Total Disturbance)

- TT. TMDL (Total Maximum Daily Load)
- UU. UDOT (Utah Department of Transportation)
- VV. UIC (Underground Injection Control)
- WW. UPDES (Utah Pollution Discharge Elimination System)
- XX. USACE (U.S. Army Corps of Engineers)
- YY. USDCM (Urban Storm Drainage Criteria Manual, Urban Drainage and Flood Control District, aka. Mile High Flood District, <https://udfcd.org/>)
- ZZ. USCS (Universal Soil Classification System)
- AAA. USGS (U.S. Geological Survey)
- BBB. WEF (Water Environment Federation)
- CCC. WQV (Water Quality Volume)
- DDD. yr (year)

#### 7.04 GENERAL STANDARDS AND REQUIREMENTS

- A. This manual provides approved methods, criteria, and details for analysis and design to be used for new development and redevelopment projects to protect water resources of Sandy City and provide detailed guidance on treatment requirements. Below is a summary of background information that has led to development of this document.
- B. Climate Change and Uncertainty Considerations
  1. Temperatures have increased by approximately 1.8 degrees Fahrenheit since 1850. <https://hazards.utah.gov/climate-change/>
  2. Extreme precipitation events are projected to increase in frequency and intensity, because a warmer atmosphere holds more water and the increase in water vapor in the atmosphere will cause more intense rainfall events. <https://hazards.utah.gov/wp-content/uploads/Utah-SHMP-Ch9-Severe-Weather.pdf>
  3. Climate models indicate there may be a 5 -15% increase in precipitation levels in Northern Utah <https://utahrivers.org/climate-change>. Most of this increase in precipitation is expected to occur during winter months.
  4. The climate models do not provide a prediction of changes in rainfall intensity.
  5. The NOAA Atlas 14 precipitation frequency estimates are based on annual data. Sandy City peak storm water runoff flowrates are due to thunderstorm events which occur generally in May through October. Winter events have larger amounts of precipitation but have less intensity. The NOAA Atlas 2 (predecessor of the NOAA Atlas 14) provided precipitation frequency estimates based on both the annual data and the May through October data. The precipitation depth frequency estimates provided for the May through October period in the NOAA Atlas 2 are about 10 to 15% less than that based on annual data.
  6. Due to climate change uncertainties and because the use of the NOAA Atlas 14 (based on annual data) overpredicts the storm depth for the thunderstorm season (May through October); it was decided to use the NOAA Atlas 14 without correction for season to provide an offset for climate change increases in storm intensity.



- C. To minimize burden on the aging infrastructure of Sandy City, it is the developer's responsibility to mitigate the effects of increase in impervious surfaces as a result of the development, by analyzing the impact of this increase on urban storm water runoff within the vicinity of the project.
- D. The impact of the project is assessed by the total footprint of new development or redevelopment projects, the increase in impervious surfaces and whether the project is part of a CPoD. Depending on any of these conditions, the project will have to follow certain steps to mitigate any impact on changes by following the steps that are followed.
- E. Where Storm Water Analysis is required, the developer shall retain the services of a Professional Engineer, registered in the State of Utah, with expertise in storm water management to complete any required studies and designs, to meet the requirements of this criteria and to mitigate any adverse impact of the development on the storm water system.
- F. In addition to considering the onsite impact of any storm water runoff, the storm water management system should be designed with the outlet or point of outflow from the project, considering downstream effects and the effects of offsite flows entering the system. The downstream conveyance system should be evaluated to ensure that it has sufficient capacity to accept any design discharges or overflows, without adverse upstream or downstream impacts such as flooding, stream bank erosion, and sediment deposition. In addition, the design of a storm water drainage system should consider the runoff from upstream sites and recognize their future development runoff potential (e.g., imperviousness). (based on USDCM, 2018)
- G. Properties are to be graded such that storm water runoff will drain away from structures and towards property boundaries. However, new development or redevelopment shall not increase the burden of storm water on neighboring and/or downstream properties. Storm water runoff shall be entirely controlled within the limits of project site. Perpetrating property owners may be liable for damages in civil courts due to damages caused to adjacent properties from runoff (including flows that existed before the new development or redevelopment occurred). Any concentrated flows leaving a site shall have an agreement/easement with the affected property owners.
- H. Storm water analysis is required for new developments and redevelopments. Table 1 provides a summary of the level of Storm Water Analysis and Drainage Plan required.
  - 1. Note that impervious areas listed under redevelopment projects refer to net increase in the impervious surfaces as a result of the redevelopment project.
- I. Where required, treatment prior to discharge shall follow the guidelines provided in this document as well as Chapter 21-17 – Drinking Water Source Protection Overlay Zone. Treatment requirement depends on the intended use for new development or redevelopment and may require pre-treatment (e.g. mechanical treatment, oil-water separator, or media filters) as well as LID practices.

**TABLE 1 - STORM WATER ANALYSIS AND DRAINAGE PLAN REQUIREMENTS**

Storm Water Requirement	NEW DEVELOPMENT			REDEVELOPMENT		
	T.D. < 1 acre I.A. < 6,000 s.f. Not Part of CPoD	T.D. < 1 acre I.A. >= 6,000 s.f. Not Part of CPoD	T.D. >= 1 acre or Part of CPoD	T.D. < 1 acre and Not Part of CPoD	T.D. >= 1 acre or Part of CPoD Incr. in I.A. < 10%	T.D. >= 1 acre or Part of CPoD Incr. in I.A. >= 10%
<b>Storm Water Analysis and Drainage Plan<sup>2</sup></b>						
Conceptual Drainage Plan	Yes	Yes	Yes	Yes	Yes	Yes
Preliminary Drainage Plan	Maybe <sup>1</sup>	Yes	Yes	Maybe <sup>1</sup>	Yes	Yes
Final Drainage Plan	Maybe <sup>1</sup>	Maybe <sup>1</sup>	Yes	Maybe <sup>1</sup>	Maybe <sup>1</sup>	Yes
Storm Water Quality Report	No	Maybe <sup>1</sup>	Yes	No	Maybe <sup>1</sup>	Yes
<b>Water Quality Site Requirements</b>						
Treatment Prior to Discharge <sup>3</sup>	Maybe <sup>1</sup>	Yes	Yes	Maybe <sup>1</sup>	Yes	Yes
Retention of 80 <sup>th</sup> Percentile Storm (WQV)	No	No	Yes	No	No	Yes

**Notes**

1) Public Utilities may require additional analysis and additional storm water controls if:

- The site is located within an area of known storm water drainage problems.
- The site is located within an area where use of Retention/Infiltration BMPs are limited or restricted because of DWSP and site conditions (see Sandy City LID Toolbox).
- There is a channel, swale, or other storm water conveyance on the site.
- The topography immediately downstream from the site obstructs the run-off in a way that may cause risk to buildings or roadways.

2) Minimum requirements for the Storm Water Analysis and Drainage Plan are provided in Section 7.08.

3) Where treatment is required:

- Basic storm water treatment facility is required using at least one LID feature.
- Pre-treatment is required for high-use sites.

TABLE 1 ABBREVIATIONS
<u>T.D.</u> (Total Disturbance)
<u>I.A.</u> (Impervious Area)
<u>CPoD</u> (Common Plan of Development or Sale which Collectively Disturbs Land Greater than or Equal to One Acre)
<u>Incr.</u> (Increase)

7.05 WATER QUALITY REQUIREMENTS

- A. Section 7.04 discussed the requirements that require completion of Storm Water Analysis and Drainage Plan and water quality requirements. This section's intent is to expand on the water quality requirements and provide guidance on how these requirements can be met.
- B. Sandy City is authorized to discharge storm water to waters of the State of Utah under the UPDES Permit No. UTS000001. All work shall implement measures to ensure that the quality of this discharge is acceptable per local and state guidelines. Water quality can be ensured using various measures including LID BMPs and pre-treatment devices to meet water quality requirements.
- C. The UPDES permit referenced above includes the following requirements related to new development and redevelopment. See the current permit and CSWMP for all requirements.
  - 1. All construction activities must prevent or minimize impacts to water quality both during and after construction. (4.2.5.1)
  - 2. Long-term post construction storm water controls are required. (4.2.5.1)
  - 3. "By July 1, 2020 new development projects that disturb land greater than or equal to one acre, including projects that are part of a larger common plan of development or sale which collectively disturbs land greater than or equal to one acre must manage rainfall on-site, and prevent the off-site discharge of the precipitation from all rainfall events less than or equal to the 80<sup>th</sup> percentile rainfall event or a predevelopment hydrologic condition, whichever is less." (4.2.5.1.2)
  - 4. If a redevelopment project (greater than or equal to 1 acre) or is part of a CPoD increases the impervious surface by greater than 10%, the project shall manage rainfall on-site, and prevent the off-site discharge of the net increase in the volume associated with the precipitation from all rainfall events less than or equal to the 80<sup>th</sup> percentile rainfall event. (4.2.5.1.2)
  - 5. Evaluation of LID is required. LID includes the implementation of BMPs that allow storm water to infiltrate, evapotranspire or harvest and use storm water on site to reduce runoff from the site and protect water quality. Evaluation may include performing geotechnical investigation to assess soil conditions and preparing a storm water management plan to show sizing of any proposed LID features. (4.2.5.1.3)
  - 6. The permittee must allow for use of a minimum of five LID practices from the list in Appendix C of "A Guide to Low Impact Development within Utah". (4.2.5.1.3)
  - 7. Documentation must include (4.2.5.2.2):
    - a) How long-term storm water BMPs were selected;
    - b) The pollutant removal expected from the selected BMPs, and
    - c) The technical basis which supports the performance claims for the selected BMPs.
  - 8. Post-construction access for City operations personnel to inspect storm water control measures on private properties is required. (4.2.5.2.3)
- D. Prior to discharge to receiving waters of the State of Utah (including the Sandy City storm water system), storm water must be treated. This will ensure illicit discharges of sediments, oils, floatables and other pollutants is minimized. Storm water treatment facilities shall be selected based on specific site characteristics.
  - 1. Following are the treatment level requirements for new development and

redevelopment:

- a) A basic storm water treatment facility is required for new development or redevelopment projects to provide treatment prior to discharge as listed in Table 1. Basic storm water treatment can be provided by at least one of the LID BMPs allowed in Sandy City. The LID BMPs must be installed and maintained by the project owner, unless an alternative technology and maintenance plan is proposed and accepted by Sandy City.
  - b) A pre-treatment facility is required (in addition to and upstream of basic storm water treatment facilities) if the new development or redevelopment project is required to provide treatment prior to discharge as listed in Table 1 and the site meets one or more of the criteria defining a high-use site, as described later in this section.
  - c) An alternative to a prescribed storm water treatment facility can and may be proposed for a project. Alternative technologies can include both structural and non-structural approaches for removing pollutants from storm water before it leaves the site.
2. The 80<sup>th</sup> percentile rainfall runoff volume (WQV) shall be retained for new development and redevelopment projects as shown in Table 1.
- a) The 80<sup>th</sup> percentile rainfall runoff volume, or WQV, is defined as:
    - i. New Development: The volume of runoff generated within the project's limits of disturbance over a 24-hour period during the 80<sup>th</sup> percentile storm event or a predevelopment condition, whichever is less.
    - ii. Redevelopment: For a redevelopment project that results in a net increase in impervious surface greater than 10%, the WQV is the net increase in volume between the existing condition and the proposed condition generated by the 80<sup>th</sup> percentile storm event over a 24-hour period.
    - iii. BMP Drainage Area: The volume of runoff generated within a BMP's drainage area over a 24-hour period during the 80<sup>th</sup> percentile storm event.
  - b) The WQV shall be calculated using the SCS CN method.
  - c) Based on the option selected for implementation of storm water control, the WQV may be included within the design retention volume (see Section 7.06 – Hydrologic Criteria).
  - d) If retention of the WQV is infeasible, "a rationale shall be provided for the use of alternative design criteria. The new or redevelopment project must document and quantify that infiltration, evapotranspiration, and rainwater harvesting have been used to the maximum extent feasible and that full employment of these controls are infeasible due to constraints. LID infeasibility may be due to one or more of the following conditions: high groundwater, drinking water source protection areas, soil conditions, slopes, accessibility, excessive costs, or others." (UPDES Permit No. UTS000001, Section 4.2.5.1.5)
3. Retention/Infiltration BMPs versus Flow-Through BMPs.
- a) Retention/Infiltration BMPs are LID features that capture, treat and infiltrate storm water runoff into underlying soils. Examples of Retention/Infiltration BMPs include bioretention, rain gardens, pervious surfaces, bioswales, infiltration trenches, infiltration basins, and subsurface storage/infiltration galleries.



- b) Where Retention/Infiltration BMPs are not allowed or feasible, Flow-Through BMPs may be used for basic storm water treatment. These type of BMPs typically include an impermeable layer and provide treatment through settling, decreased flow rate, and bioretention with a designed release time. Examples of Flow-Through BMPs include bioswales, vegetated strips, and tree box filters.
  - c) Infiltration of storm water in DWSP Zones 1 and 2 (Exclusion Zones) is not allowed. Storm water shall be discharged off-site after required treatment is performed. If landscaped areas are anticipated to receive urban runoff, they shall be lined with an impermeable liner to protect drinking water zones. In addition to the Exclusion Zones, Retention/Infiltration BMPs are not allowed in areas with the following site conditions:
    - i. Presence of clayey soils with unacceptable infiltration rates.
    - ii. Historic ground water level is within two feet of the bottom of a proposed BMP.
    - iii. Contaminated soils.
    - iv. Slopes greater than 10 percent.
  - d) Retention/Infiltration BMPs shall be sized to retain as a minimum the WQV where required. However, the WQV may be included in the required storm water control facility volume (see Section 7.06 – Hydrologic Criteria).
  - e) Flow-Through BMPs shall be designed to convey/treat runoff from a 2-year 3-hour storm event.
- 4. For sumps, both a pre-treatment facility and a basic storm water treatment facility are required.
  - 5. New development and redevelopment projects must meet the water quality site requirements in Table 1.
- E. “A Guide to Low Impact Development within Utah” (Utah LID Guide) <https://deg.utah.gov/water-quality/low-impact-development> (December 2018, revised August 2020) provides guidance for implementation of LID in Utah. The Sandy City LID Toolbox builds on the Utah LID Guide and will assist in the implementation of LID for new development and redevelopment projects within Sandy City. The Sandy City LID Toolbox shall be used in conjunction with this document and the Utah LID Guide.
- F. LID BMPs allowed in Sandy City include the following (see LID BMP Fact Sheets in Section 7.09 – LID BMP Fact Sheets):
- 1. Bioretention Features.
  - 2. Permeable Pavements.
  - 3. Wetlands, Dry or Wet Ponds.
  - 4. Vegetated Swales
  - 5. Underground Detention and Infiltration Systems.
  - 6. Vegetated Strips.
  - 7. Vegetated Basins.

- G. A high-use area is an area that meets any of the following criteria:
1. Expected average daily traffic counts exceeding 100 vehicles per 1,000 square feet of gross building area, such as an uncovered parking lot, convenience market, supermarket, shopping mall, discount store, liquor store, movie theater, athletic club or a bank.
  2. Petroleum storage or transfer areas (excluding delivered heating oil), including gas stations with underground storage tanks.
  3. Road intersections with a measured average daily traffic of 25,000 vehicles or more on the main roadway and 15,000 or more on any intersecting roadways. Projects proposing primarily pedestrian or bicycle use improvements are excluded.
  4. Agricultural pesticide, herbicide, and fertilizer storage, use, filling, and mixing areas, dairy farms and animal feed lots with more than 10 animal units, farm operations and manure piles.
  5. Airport maintenance and fueling sites.
  6. Auto operations and fleet vehicle maintenance facilities (commercial), including dealership maintenance departments, tire shops, auto body stores, engine repair, rust proofing shops, oil and lube shops, vehicle rental with maintenance and car washes.
  7. Boat building and refinishing.
  8. Chemical reclamation facilities.
  9. Chemigation wells.
  10. Concrete, asphalt, and tar companies.
  11. Dry cleaners, with onsite chemicals.
  12. Embalming services.
  13. Dump sites and recycling centers.
  14. Maintenance garages.
  15. Food processing, meat packing, and slaughterhouses.
  16. Furniture stripping, painting, and finishing businesses.
  17. Industrial manufacturers of: chemicals, pesticides, herbicides, paper products, leather products, textiles, rubber, plastic, fiberglass, silicone, glass, pharmaceuticals, and electrical equipment, etc.
  18. Industrial waste disposal/impoundment areas.
  19. Junk and salvage yards.
  20. Landfills and transfer stations.
  21. Machine shops, metal plating, heat treating, smelting, annealing, and descaling

facilities.

22. Mining operations including radiological, sand and gravel excavation and processing.
23. Municipal wastewater treatment plants.
24. Railroad yards.
25. Residential pesticide, herbicide, and fertilizer storage, use, filling, and mixing areas.
26. RV waste disposal stations.
27. Salt and salt-sand piles.
28. Septic tank drain field systems.
29. Sumps.
30. Toxic chemical storage and oil pipelines.
31. Wood preservative treatment facilities.

H. Where required, pre-treatment devices shall be installed and maintained in accordance with requirements for operation and maintenance of such facilities. Pre-treatment devices shall be maintained as a minimum twice each year (around March and October), and in accordance with the guidelines provided by the manufacturer and Sandy City, whichever is greater. Allowable pre-treatment devices include the following:

1. Mechanical treatment device such as a hydrodynamic separator.
  - a) Technical design information, shop drawings, details, and maintenance requirements necessary for maintenance shall be submitted for approval by Sandy City.
2. Baffle Oil-Water Separator (API) – This type of oil-water separator is most suitable for project sites that are expected to produce relatively high concentrations of oil and grease, with droplet sizes of 150 microns or larger.
  - a) The baffle oil-water separator shall be divided into three compartments: a forebay, an oil separation cell which houses the plate pack, and an afterbay.
    - i. The forebay controls turbulence and traps and collects debris.
    - ii. The oil separation cell captures and holds oil.
    - iii. The afterbay provides a relatively oil-free exit cell before the outlet.
  - b) The structure shall meet HS-20 loading requirements.
  - c) The length of the forebay shall be approximately 1/3 to 1/2 of the length of the vault, L.
  - d) The surface area of the forebay must be at least 20 square feet per 10,000 square feet of tributary impervious area draining to the separator.
  - e) A removable oil retaining baffle shall be provided and located approximately 1/4 L from the outlet wall or a minimum of 8 feet, whichever

is greater (minimum distance is provided for maintenance purposes), covering at least 50% of the depth of the water measured from the surface.

- f) Baffles may be fixed rather than removable, if additional entry ports and ladders are provided so that sides of the baffle are accessible by maintenance crews.
  - g) Baffle oil-water separator vaults shall have a minimum length-to-width ratio of 5.
  - h) The design water depth shall be no deeper than 8 feet, unless approved by Sandy City.
  - i) Baffle oil-water separator vaults shall have a design water depth-to-width ratio of between 0.3 between 0.5.
  - j) Must be designed so that the flows during the first 15 minutes of a 2-year, 3-hour storm will be allowed to stay in the detention/holding area of the separator for a time sufficient for 98 % of the oil to rise above the outlet side of the central chamber.
  - k) Includes a bypass for higher flows beyond the first 15 minutes of a 2-year, 3-hour storm to flow outside the separator without flushing the separator out.
3. Coalescing Plate Oil-Water Separator (CPI) – This type of oil-water separator may be used to treat storm water from project sites that produce high concentration of oil and grease and is capable of removing droplets as small as 20 to 60 microns.
- a) The coalescing plate oil-water separator shall be divided by baffles or berms into three chambers: a forebay, an oil separation cell and an afterbay.
    - i. The forebay is primarily to trap and collect sediments, encourage plug flow, and reduce turbulence.
    - ii. The oil separation cell traps and holds oil as it rises from the water column, and it serves as a secondary sediment collection area.
    - iii. The afterbay provides a relatively oil-free cell before the outlet and can serve as a secondary oil separation area and holds oils entrained by high flows.
  - b) The structure shall meet HS-20 loading requirements.
  - c) The length of the forebay shall be a minimum of  $1/3$  the length of the vault,  $L$  (but  $1/2 L$  is recommended). In addition, it is recommended that the surface area of the forebay be at least 20 square feet per 10,000 square feet of tributary impervious area draining to the separator. In lieu of an attached forebay, a separate grit chamber, sized to be at least 20 square feet per 10,000 square feet of tributary impervious area, may precede the oil-water separator.
  - d) An oil-retaining baffle shall be provided. For large units, a baffle position of  $0.25L$  from the outlet wall is recommended. The oil-retaining baffle shall extend from the water surface to a depth of at least 50% of the design water depth. Various configurations are possible, but the baffle shall be designed to minimize turbulence and entrainment of sediment.
  - e) A bottom sediment-retaining baffle shall be provided upstream of the plate pack. The minimum height of the sludge-retaining baffle shall be 18 inches. Window walls may be used, but the window opening must be a minimum of three times greater than the area of the inflow pipe.

- f) The separator plates shall meet the following requirements:
    - i. Plates shall be inclined at 45° to 60° from the horizontal. This range of angles exceeds the angle of repose of many solids and therefore provides more effective droplet separation while minimizing the accumulation of solids on the individual plates.
    - ii. Plates shall have a minimum plate spacing of 1/2-inch and have corrugations.
    - iii. Plates shall be securely bundled in a plate pack so that they may be removed as a unit.
    - iv. The plate pack shall be a minimum of 6 inches from the vault bottom.
    - v. There shall be 1 foot of head space between the top of the plate pack and the bottom of the vault cover.
  - g) It is recommended that entire space between the sides of the plate pack and the vault wall be filled with a solid but light-weight removable material such as a plastic or polyethylene foam to reduce short-circuiting around the plate pack. Rubber flaps are not effective for this purpose.
  - h) Must be designed so that the flows during the first 15 minutes of a 2-year, 3-hour storm will be allowed to stay in the detention/holding area of the separator for a time sufficient for 98 % of the oil to rise above the outlet side of the central chamber.
  - i) Includes a bypass for higher flows beyond the first 15 minutes of a 2-year, 3-hour storm to flow outside the separator without flushing the separator out.
4. Media Filters – Some sand media filters may be used to satisfy the treatment requirements of high-use sites, using a linear sand filter. This type of filter may also be used as an oil control on the high-use project sites. If a media filter is used to satisfy the requirements listed here for basic and high-use treatment sites, it must be inspected and maintained quarterly.
5. If a different storm water treatment device other than those specified above is desired, technical information about the proposed product shall be submitted with all design information demonstrating that the product meets or exceeds the requirements above.



7.06 **HYDROLOGIC CRITERIA**

- A. Precipitation depths are determined based on the NOAA Atlas 14-Point Precipitation Frequency Estimates data server using the partial duration series data.  
[https://hdsc.nws.noaa.gov/hdsc/pfds/pfds\\_map\\_cont.html?bkmrk=ut](https://hdsc.nws.noaa.gov/hdsc/pfds/pfds_map_cont.html?bkmrk=ut)
- B. Storm Water Drainage Design Frequency (level of service, see Figure 1)
  - 1. Minor System: The minor (or initial) storm water drainage system includes those components which provide protection against regularly recurring damage from storm runoff in a minor storm event. Minor storm water drainage systems include LID BMPs, curb and gutter, streets, storm sewers, and detention and retention basins. These systems shall be designed to safely convey the 10-year storm runoff event. The systems in sensitive overlay areas shall be designed to safely convey the 25-year storm runoff event.
  - 2. Major System: The major storm water drainage system includes those components which provide protection against larger, typically rare storms. Included in the major storm water drainage system are streets (including overtopping of curb onto lawn area), large conduits, open channels, swales, and detention and retention facilities. This system shall be designed for the 100-year event with the objective to eliminate major damage to structures, homes, and businesses, and to prevent loss of life.

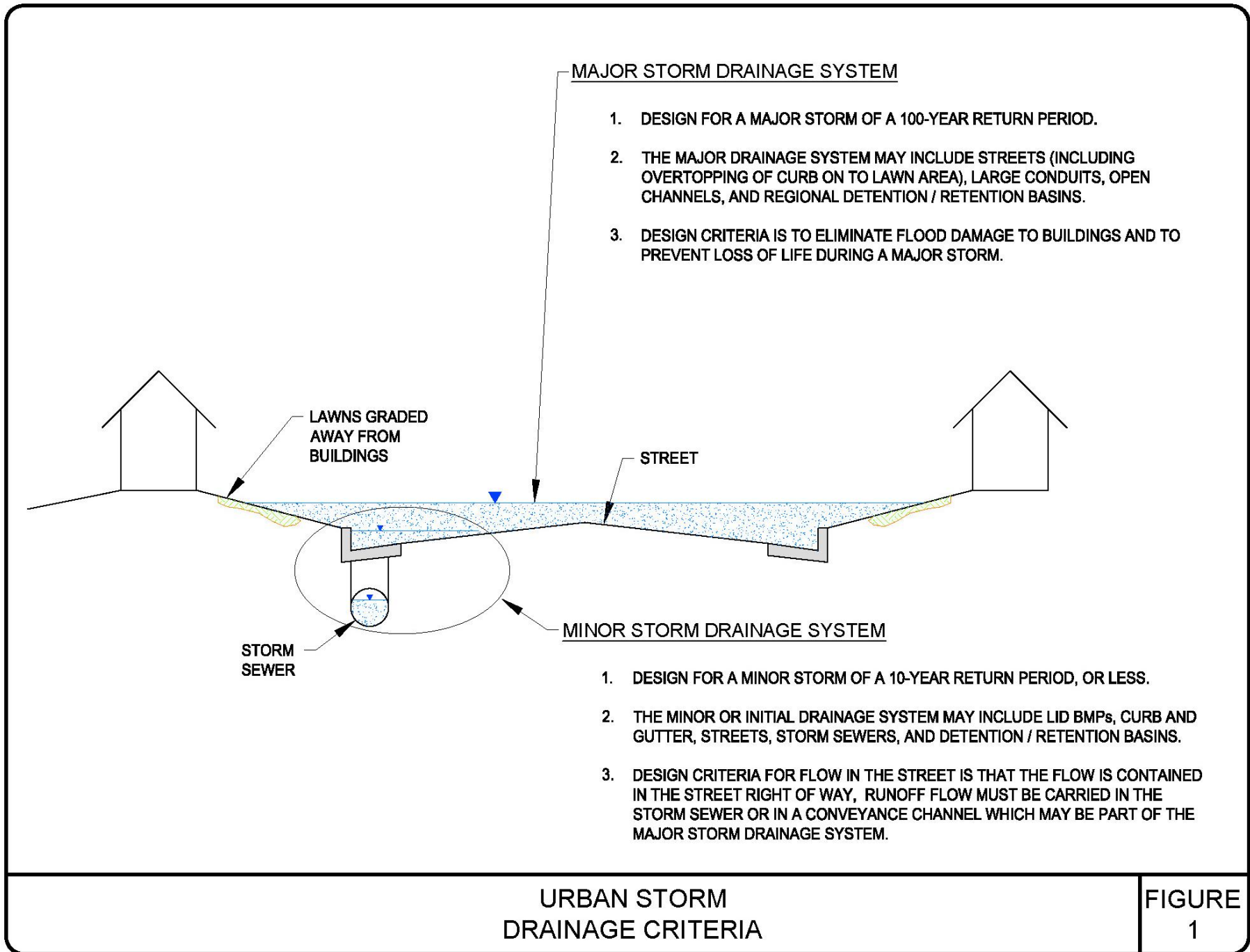

C. Design Storm Distribution

1. The storm distribution in Table 2 shall be used in storm runoff analyses.

**TABLE 2 – STORM DISTRIBUTION**

<b>Time (minutes)</b>	<b>Accumulative Precipitation / Total Precipitation</b>
0	0
5	0.002
10	0.004
15	0.007
20	0.010
25	0.014
30	0.018
35	0.022
40	0.026
45	0.031
50	0.037
55	0.043
60	0.050
65	0.302
70	0.507
75	0.646
80	0.734
85	0.794
90	0.836
95	0.865
100	0.887
105	0.904
110	0.919
115	0.934
120	0.950
125	0.957
130	0.963
135	0.969
140	0.974
145	0.978
150	0.982
155	0.986
160	0.990
165	0.993
170	0.996
175	0.998
180	1

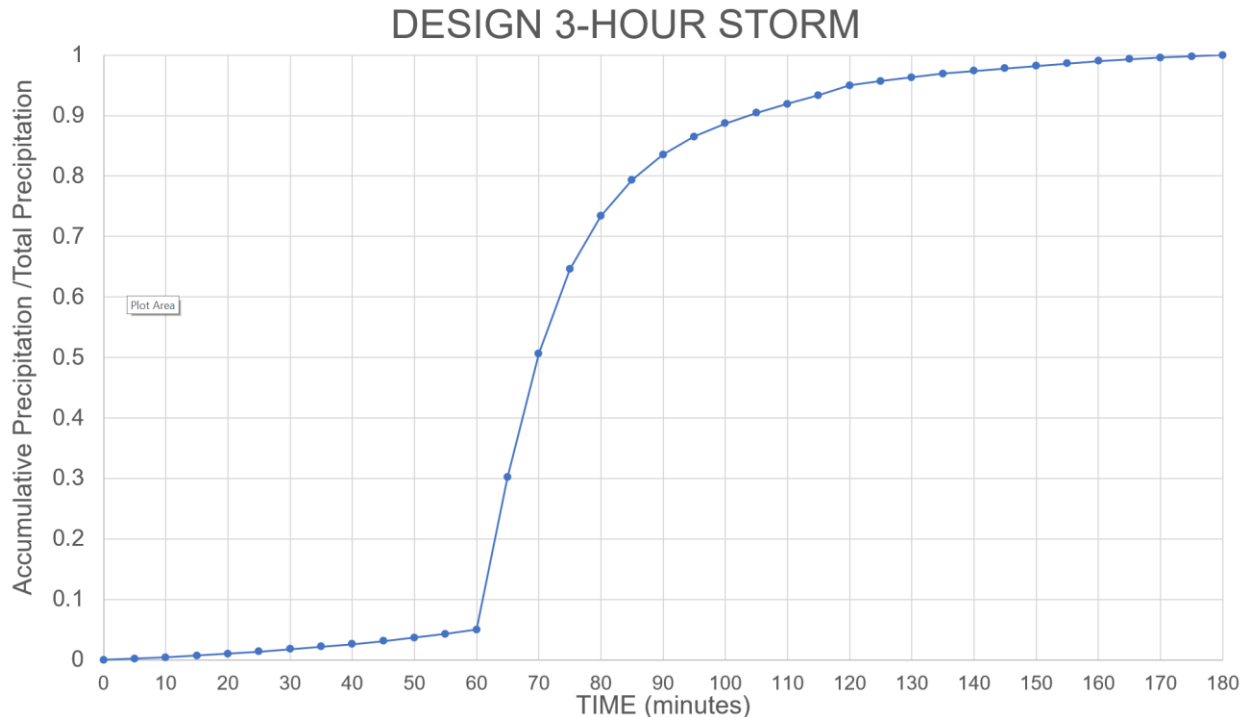

**FIGURE 2 – ACCUMULATIVE STORM PRECIPITATION FOR A GIVEN TIME IS FOUND BY MULTIPLYING THE VALUES IN TABLE 3 BY THE DESIGN 3-HOUR STORM DEPTH**

D. Storm Water Modeling Methods

1. Computation of design peak storm runoff flowrates may use the following methods.
  - a) The Rational Method may be used to compute design peak storm runoff flowrates for drainage areas up to 10 acres in Sandy City. The rational method procedures are described in “Hydraulic Engineering Circular No. 22” (HEC-22) in Section 3.2.2.
  - b) The EPA SWMM <https://www.epa.gov/water-research/storm-water-management-model-swmm> may be used for computation of design peak storm runoff flowrates and for hydrographs for design of detention basins.
  - c) The Army Corps of Engineers Hydrologic Engineering Center – Hydrologic Modeling System (HEC-HMS) <https://www.hec.usace.army.mil/software/hec-hms/> may be used for computation of design peak storm runoff flowrates and for hydrographs for design of detention basins.
2. The SCS NRCS curve number methodology will be used to model infiltration with either SWMM or HEC-HMS.
3. A potential development impact is caused by increases in impervious area. Impervious areas consist of directly connected impervious areas and impervious areas which drain to a pervious area. General examples of directly connected impervious areas are streets, driveways, portions of the home which discharge onto the driveway, etc. Examples of unconnected impervious areas are back yard patios which drain onto lawn and portions of a building roof which drain onto the lawn.
4. Sub-basins shall be divided into pervious and impervious sub-catchments. The directly connected impervious areas in a development will be modeled as an impervious sub-catchment. The unconnected impervious areas may be composited with the pervious areas by area weighting and modeled as part of the

pervious sub-catchment.

5. CN tables for Sandy City. Hydrologic Soil Type will be defined based on the on-site soils and shall be selected as either C or D for developed conditions. NRCS provides an online soil data server at <https://websoilsurvey.sc.egov.usda.gov/App/HomePage.htm> which can assist with definition of hydrologic soil type. CNs for developed conditions shall be selected from Table 3 (see below). CNs for undeveloped areas shall be selected from Table 4 (see below).

**TABLE 3 – CURVE NUMBERS FOR DEVELOPED URBAN AREAS**

Cover Type and Hydrologic Condition	Curve Numbers for Hydrologic Soil Group	
	C	D
Impervious areas	98	98
<b>Open space (lawns, parks, golf courses, cemeteries, etc.)</b>		
Poor condition (grass cover < 50%)	86	89
Fair condition (grass cover 50% to 75%)	79	84
Good condition (grass cover > 75%)	74	80

**TABLE 4 – CURVE NUMBERS FOR UNDEVELOPED AREAS**

Cover description	Hydrologic condition <sup>2/</sup>	Curve numbers for hydrologic soil group			
		A <sup>3/</sup>	B	C	D
Herbaceous—mixture of grass, weeds, and low-growing brush, with brush the minor element.	Poor		80	87	93
	Fair		71	81	89
	Good		62	74	85
Oak-aspen—mountain brush mixture of oak brush, aspen, mountain mahogany, bitter brush, maple, and other brush.	Poor		66	74	79
	Fair		48	57	63
	Good		30	41	48
Pinyon-juniper—pinyon, juniper, or both; grass understory.	Poor		75	85	89
	Fair		58	73	80
	Good		41	61	71
Sagebrush with grass understory.	Poor		67	80	85
	Fair		51	63	70
	Good		35	47	55
Desert shrub—major plants include saltbush, greasewood, creosotebush, blackbrush, bursage, palo verde, mesquite, and cactus.	Poor	63	77	85	88
	Fair	55	72	81	86
	Good	49	68	79	84

<sup>1</sup> Average runoff condition, and  $I_{a,b} = 0.2S$ . For range in humid regions, use table 2-2c.

<sup>2</sup> Poor: <30% ground cover (litter, grass, and brush overstory).

Fair: 30 to 70% ground cover.

Good: > 70% ground cover.

<sup>3</sup> Curve numbers for group A have been developed only for desert shrub.



## EXAMPLE 1 – ONE ACRE RESIDENTIAL

### Site Information

- Hydrologic Soil Type C
- 1 Acre Total Area
- 20% Directly Connected Impervious Area with a CN of 98
- 80% Mix of Unconnected Impervious / Pervious Areas
  - 70% Pervious Area (grass good condition) with a CN of 74
  - 10% Unconnected Impervious Area with a CN of 98

### Calculation

Composite CN for 80% Unconnected Impervious / Pervious area =

- (Unconnected Impervious Area x 98 + Pervious Area x 74) divided by (the Pervious Area plus the Unconnected Impervious Area)
- $(0.1 \times 98 + 0.7 \times 74) / (0.1 + 0.7) = 77$

Therefore for this example, one subcatchment in SWMM would model the Directly Connected Impervious sub-catchment with a CN = 98 representing 20% of the total area, and the other subcatchment with combined Unconnected Impervious and Pervious Areas would have a CN = 77 with 80% of the total area.

## EXAMPLE 2 – FIVE ACRE COMMERCIAL SITE

### Site Information

- Hydrologic Soil Type C
- 5 Acres Total Area
- 60% Directly Connected Impervious Area with a CN of 98
- 40% mix of Unconnected Impervious / Pervious Areas
  - 20% Pervious Area (grass good condition) with a CN of 74
  - 20% Unconnected Impervious Area with a CN of 98

### Calculation

Composite CN for 40% Unconnected Impervious / Pervious area =

- (Unconnected Impervious Area x 98 + Pervious Area x 74) divided by (the Pervious Area plus the Unconnected Impervious Area)
- $(0.2 \times 98 + 0.2 \times 74) / (0.4) = 86$

Therefore for the commercial site example, one subcatchment in SWMM would model the Directly Connected Impervious sub-catchment with a CN = 98 representing 60% of the total area, and the other subcatchment with combined Unconnected Impervious and Pervious Areas would have a CN = 86 with 40% of the total area.

## 7.07 DESIGN CRITERIA

### A. Street Design and Drainage

#### 1. Downhill Cul-De-Sacs and Sags in Profile not at an Intersection.

- a) Downhill cul-de-sacs and dead-end streets which slope downhill to the end of the street are prohibited unless specifically authorized by Public Utilities.
- b) Sags in street profile which are not located at an intersection are prohibited unless specifically authorized by Public Utilities. Public Utilities may authorize sags if it is impractical to grade a street to avoid sags at locations other than at street intersections and if a suitable surface overflow and storm water system designed for the 100-year storm runoff event is provided which has adequate access for maintenance. All-weather access roads of 15 feet minimum width and 15% maximum slope shall be provided to all structures including open channels, grade control structures, manholes, and junctions.

### B. T-Intersections where a street slopes downhill to a T-intersection require special care to assure that homes on the downhill side of the T are not impacted in a 100-year flood event.

- C. Gutter flow computations shall use Manning's equation (reference FHWA HEC-22).
  - 1. Minimum gutter slope 0.4%;
  - 2. Minimum Manning's n values for street and pavement gutters are provided in Table 5.

**TABLE 5 – MANNING'S n FOR STREET AND PAVEMENT GUTTERS**

Type of Gutter or Pavement	Manning's n
Concrete gutter, troweled finish	0.012
<b>Asphalt Pavement</b>	
Smooth texture	0.013
Rough texture	0.016
<b>Concrete gutter-asphalt pavement</b>	
Smooth	0.013
Rough	0.015
<b>Concrete pavement</b>	
Float finish	0.014
Broom finish	0.016

- 3. Reduction factors for gutter flow with street slope are reproduced in Figure 3. Allowable gutter flowrates are found by multiplying the theoretical flowrate computed using the Manning's equation by the reduction factor shown on Figure 3.

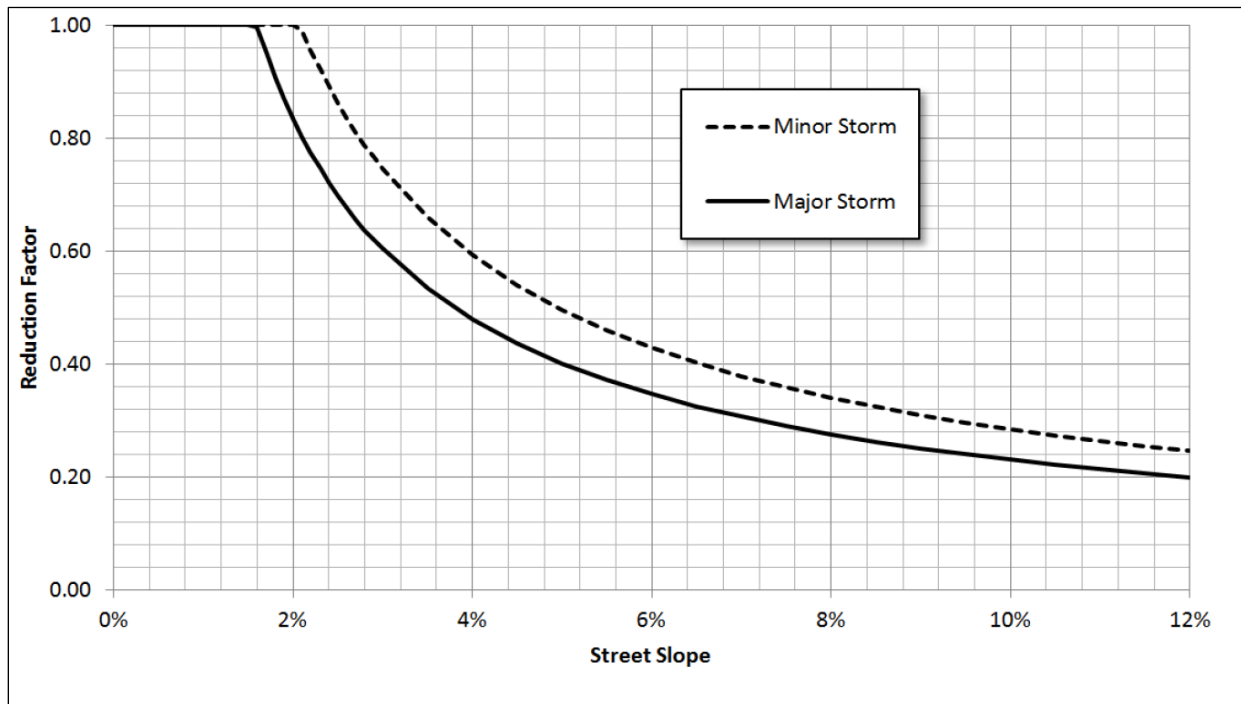

**FIGURE 3 – REDUCTION FACTOR FOR GUTTER FLOW (AFTER USDCM, 8018, FIGURE 7.4)**

- D. Street storm runoff spread, encroachment, and inundation standards are provided in Tables 6, 7 and 8.

**TABLE 6 – STREET INUNDATION STANDARDS FOR MINOR STORM**

<b>Street Classification</b>	<b>Maximum Encroachment and Inundation</b>
Local	Runoff flow contained in right-of-way. Flow may spread to crown of street
Collector	Runoff flow contained in right-of-way. Flow spread must leave at least one lane free of water
Arterial	Runoff flow contained in right-of-way. Flow spread must leave at least one lane free of water in each direction, and shall not flood more than two lanes in each direction

**TABLE 7 – STREET INUNDATION STANDARDS FOR MAJOR STORM**

<b>Street Classification</b>	<b>Maximum Encroachment and Inundation</b>
Local and Collector	Residential dwellings and public, commercial, and industrial buildings shall be no less than 12 inches above the 100-year flood at the ground line or lowest water entry of the building. The depth of water over the gutter flow line shall not exceed 12 inches
Arterial	Residential dwellings and public, commercial, and industrial buildings shall be no less than 12 inches above the 100-year flood at the ground line or lowest water entry of the building. The depth of water shall not exceed the street crown to allow operation of emergency vehicles. The depth of water over the gutter flow line shall not exceed 12 inches

**TABLE 8 – STANDARDS FOR CROSS STREET FLOW**

<b>Street Classification</b>	<b>Minor Storm Flow</b>	<b>Major Storm Flow</b>
Local	6 inches of depth in cross-pan	12 inches of depth above gutter flow line
Collector	Where cross-pans allowed, depth of flow shall not exceed 6 inches	12 inches of depth above gutter flow line
Arterial	None	No cross-flow. Maximum depth at upstream gutter on road edge of 12 inches.

- E. Storm Drain Inlets
1. The following clogging factors shall be used for design of single inlets:
    - a) 50% clogging for the design of a single grate inlet without curb opening, and

**Sandy City Corporation - Prod. 12/20**

- b) 10% clogging for a single curb-opening inlet without grate.
- 2. See USDCM (<https://udfcd.org/criteria-manual>) for reduction factors for multiple inlets.
- 3. A maximum of 600 linear feet is allowed between curb inlet boxes in roadways.

**F. Storm Drains**

- 1. Storm drain size and material:
  - a) In Sandy City right-of-way or maintained by Sandy City – Minimum diameter of 15-inch and shall be RCP.
  - b) On private property (12-inch diameter or larger) and not maintained by Sandy City – Minimum diameter of 15-inch and shall be RCP or polypropylene pipe (ADS HP storm pipe or approved equal).
  - c) Pipes smaller than 12-inch diameter – PVC SDR 35 may be used.
- 2. The minimum design flow velocity for storm water pipe systems is 3 fps. If the minimum design flow velocity cannot be achieved, Public Utilities may accept an alternative minimum design velocity depending upon acceptable access for cleaning and enhanced pre-treatment.
- 3. Design cover is 2 feet (18-inch cover may be approved by Public Utilities).
- 4. Minimum vertical separation from outside edge of storm drain to outside edge of crossing utility is 1 foot.
- 5. Minimum horizontal separation from outside edge of storm drain to outside edge of all other utilities is 2 feet.
- 6. Alignments - pipe shall be installed directly between manholes or cleanout boxes with no curve or change in slope.
- 7. A maximum of 300 linear feet is allowed between clean out manholes.
- 8. New storm water systems shall have a balanced hydraulic design. Storm water system inlet capacity shall not exceed pipe capacity at any point in the system.
- 9. Storm water system hydraulic designs shall use HEC-22 energy grade line evaluation methodology.
- 10. For design, the minimum coefficients in Table 9 shall be used.

**TABLE 9 – MANNING’S n FOR SMOOTH INSIDE WALL STORM DRAINS**

Type of Pipe	Manning’s n
HDPE PVC RCP (pre-cast)	0.013
Cast in Place Concrete	0.016

- G. Storm Water Flow Control – Options for storm water flow control are summarized in Table 10 on the following page:

TABLE 10 – STORM WATER FLOW CONTROL OPTIONS

Storm Water Flow Control Options	Description	Design Storage Volume	Design Release Rate	WQV	Overflow Analysis Required <sup>1</sup>	Examples
Option A	Where feasible (see 7.05 – Water Quality Requirements) retain and infiltrate storm water runoff <b>near the source of runoff</b> using LID Retention/Infiltration BMPs. LID BMPs shall not be concentrated but dispersed throughout site.	Retention: 10-yr 24-hr	Design infiltration rates may be used	May be included in design retention storage volume	Yes	Bioretention, rain gardens, pervious surfaces, bioswales, infiltration trenches, infiltration basins, storage/infiltration galleries, etc.
Option B-1	Detain and release storm water runoff using detention for the 10-yr 3-hr storm event to control storm water discharge. <b>*May be used in combination with Retention/Infiltration BMPs (see Option A)<sup>2</sup>.</b>	Detention: 10-yr 3-hr  Retention: 10-yr 24-hr	0.1 to 0.2 cfs/acre <sup>3</sup>	Detention only: WQV needs to be maintained in addition to design detention volume (i.e. storage volume below flow line of outlet pipe)	Yes	Detention ponds, wetlands, dry or wet ponds  Retention/Infiltration BMPs (see Option A)
Option B-2 <sup>4</sup>	If requirements of Option A or Option B-1 cannot be met, then detain and release storm water runoff using detention for the 10-yr 3-hr and 100-yr 3-hr storm events <sup>5</sup> . <b>*May be used in combination with Retention/Infiltration BMPs (see Option A)<sup>2</sup>.</b>	Detention: 10-yr 3hr/ 100-yr 3-hr  Retention: 10-yr 24-hr	0.1 to 0.2 cfs/acre <sup>3</sup>	Retention/detention combination: WQV can be included in the design retention volume	Yes	
Option B-3 <sup>4</sup>	If requirements of Option A, Option B-1 and Option B-2 cannot be met, then retain storm water runoff for the 100-yr 24-hr storm event.	Retention: 100-yr 24-hr	Design infiltration rates may be used	May be included in design retention storage volume	No	Retention ponds, wetlands, dry or wet ponds  Retention/Infiltration BMPs (see Option A)

**Notes**

- 1) Overflow analysis shall demonstrate that in a 100-year 3-hour storm runoff overflow from the site will be safely conveyed and meet Major System storm water design criteria requirements (designed for the 100-year event to prevent major damage to structures, homes, and businesses, and to prevent loss of life). If this cannot be achieved, one of the other options for storm water flow control shall be used.
- 2) Use of Retention/Infiltration LID BMPs can reduce the detention volume through infiltration of storm water runoff near the source of runoff.
- 3) Allowable release rate is based on downstream conveyance system capacity, as determined by Public Utilities.
- 4) Storm water system shall be designed to convey the 100-year 3-hour storm runoff flow into the storm water control facilities.
- 5) The Storm Water Analysis must include the effects of storage and outlet stage-discharge relationships for the 10-year and 100-year events.



1. Residential Storm Water Flow Control Requirements
  - a) Residential subdivision storm water flow control elements shall be designed to accommodate the tributary areas of the site, including but not limited to:
    - i. Roads.
    - ii. Curb and gutter.
    - iii. Driveways.
    - iv. Parkstrips.
    - v. Sidewalks.
    - vi. Fronts of yards that slope toward the street.
    - vii. Portions of homes that drain toward the street.
    - viii. Other areas of the development that are tributary to the street.
  - b) Each residential lot is required to retain storm water on site, except for the portion of the lot that drains toward the street and/or to subdivision storm water flow control feature(s) as long as the downstream storm water system can accommodate the flows, during and after construction. This can be accomplished by use of swales, retention areas, berms, planter beds, underground infiltration, etc.
2. Additional Detention/Retention Design Criteria
  - a) **Emergency Spillway:** An emergency spillway shall be included in the design of storm water flow control options. The spillway shall be designed in such a manner as to protect impound embankments, nearby structures and surrounding properties. The elevation of the top of the embankment shall be a minimum of one foot above the water surface elevation when the emergency spillway is conveying the maximum design or emergency flow. The design elevation of the embankment shall be increased to account for long term settlement and consolidation as defined in a geotechnical study report for the embankment (for example, if the geotechnical study predicts a long-term settlement of 6 inches due to the embankment loading of the subsoils, then the design elevation of the embankment will be increased by 6 inches to accommodate settlement). The emergency spillway design flow shall be at least the 100-year 3-hour peak inflow to the facility.
  - b) **Safety:** Containment basins may attract people, especially children. They often create a safety hazard when the basin is readily accessible to the public and designed without a safety plan. Basin designs shall include side slopes of 3 horizontal to 1 vertical (3H:1V) or less steep and may require escape facilities and inlet and outlet structures which will not cause individuals to become drawn toward them or entrapped. If slopes steeper than 3H:1V (for example rock protected slopes) are proposed, then additional safety/securing measures are required such as secure fences.
  - c) **Access:** Maintenance access to the basins shall be provided. Access roads shall be provided to the outlet structure and to the detention/retention basin floor if the basin floor cannot be maintained from the top of the basin. Required access includes heavy equipment access of 15 feet minimum width and 15% maximum slope and all-weather access to the outlet facilities.
  - d) The detention/retention basin floor and side slopes shall be vegetated in areas where infiltration is allowed. The detention/retention basin floor shall be a minimum of two feet above the historic high groundwater table. Concrete lining may be required in areas where infiltration is not allowed.

**3. Design Infiltration Rates**

- a) Long Term Infiltration Rate: Infiltration rates may appear to be adequate during infiltration rate testing and immediately after completion of the basin. However, leaves, other vegetative matter and fine-grained sediments may build up on the basin's bottom and sides. This may reduce the infiltration rate. If these issues are not considered in the design, the basin may retain water for much longer than expected.
- b) A professional geotechnical engineer, geologist, or soil scientist licensed in Utah must perform site-specific geotechnical investigation to determine the design infiltration rate. The investigation must be completed at the location of the proposed retention (or infiltration) facility and include evaluation of any topsoil or landscaping material that will be placed to obtain a true post-construction infiltration rate. Soils below the proposed facility must be classified in accordance with the USCS using ASTM D4318.
- c) Infiltration shall be measured in the field at the same location and depth as the proposed retention (or infiltration) facility using the double ring infiltrometer test (ASTM D3385). A minimum of two tests shall be performed with a minimum of one test for each 10,000 square feet of retention basin floor. The design infiltration is defined as the smallest measured infiltration rate divided by 2.5.
- d) Alternatively, in place of performing the double ring infiltrometer test, the infiltration rate may be defined using the Universal Soil Classification for the most restrictive soil layer determined by the professional (see item b above). Infiltration rates for various soil textures are provided in Table 11.
- e) A Safety Factor of 2.5 is required. The design infiltration rate is equal to the table value divided by 2.5. For example, for a Silt Loam soil texture the table value is 0.25 inches per hour and the design infiltration rate would be 0.1 inches per hour ( $0.25 \text{ in/hr} / 2.5 = 0.1 \text{ in/hr}$ ).

**TABLE 11 – INFILTRATION RATES**

<b>NRCS Hydrologic Soil Group</b>	<b>Typical Soil Texture</b>	<b>Saturated Infiltration Rate (in/hr)</b>
A	Sand	8
A	Loamy Sand	2
B	Sandy Loam	1
B	Loamy Sand	0.5
C	Silt Loam	0.25
C	Sandy Clay Loam	0.15
D	Clay Loam & Silty Clay Loam	<0.09
D	Clay	<0.05

**H. Storm Water Pump Station and Pressurized Storm Water Mains**

- 1. Pressurized storm water systems are only allowed in private storm water systems.
- 2. Storm water pump stations must be designed for current and future flows. Pump stations design flow rates shall be consistent with Section 7.06 – Hydrologic Criteria.
- 3. Downstream effects on channels and conduits must be mitigated. The cost for required modifications or upgrades to any downstream conveyance shall be borne by the development generating the increased flows.

**Sandy City Corporation - Prod. 12/20**

4. A pressurized line may not connect directly to a public manhole, cleanout box, or inlet. The pressurized line may connect to a private manhole prior to gravity flow into the public storm drain.

I. Class V Underground Injection Control Wells

1. Class V UIC storm water wells are typically shallow disposal wells designed to place storm water or melted snow below the land surface. Based on the UIC definitions in UAC R317-7-2, storm water controls that qualify as UIC wells include but are not limited to:
  - a) Sumps, drywells and drill holes.
  - b) Infiltration galleries.
  - c) Commercially manufactured storm water infiltration devices (such as Storm Tech).
  - d) Seepage pits & improved sinkholes.
2. Class V UIC wells shall be registered with the DEQ. The "Utah Underground Injection Control Program Inventory Information" form must be submitted to DEQ and provide confirmation of receipt by DEQ.
3. Class V UIC wells (including sumps) are not permitted in DWSP Zones 1 and 2. Storm water requires treatment prior to Class V UIC wells to help assure contaminants are not introduced into the groundwater (see Section 7.05 – Water Quality Requirements).

J. Sumps

1. For sites where a connection to a storm water collection system is not available or storm water system capacity is limited, and direct underground infiltration or injection is needed (including sumps), Sandy City Public Utilities must review the proposed project and provide written approval.
2. The design infiltration rate of the soil may be used as a discharge rate. The design infiltration rate is defined the same as for retention facilities (see Storm Water Control Facilities section above) and is equal to the table value divided by 2.5.
3. Any existing sump must be replaced with a new sump, or it must be shown and accepted that the existing sump is adequate.
4. The Developer shall submit plans and details of the sump design. If gravel is used in the sump, 1 ½ – 2-inch (min.) gravel shall be specified, with a maximum void ratio of 40%.

**7.08 STORM WATER DRAINAGE PLAN SUBMITTAL REQUIREMENTS**

A. Storm Water Analysis and Drainage Plan Process

1. The Storm Water Analysis addresses at a detailed level the existing site hydrologic conditions and the proposed drainage plan to accommodate or modify the site drainage conditions in the final improvement plan for the site. The Storm Water Analysis addresses both on-site and off-site drainage analysis and improvements necessary to mitigate the impact of the proposed development on adjacent properties in accordance with current Utah Drainage Law.
2. The submittal and review process requirements are tailored to provide the minimal amount of information necessary for each development process and size of development in order to minimize the cost of storm water analysis as well as to minimize the time necessary for Sandy City Public Utilities review. The submittal and review process do not, however, relieve the design engineer of the responsibility to provide a correct and safe drainage design nor the developer to properly construct the designed drainage facilities. By reviewing and approving storm water drainage designs for given developments, neither the City nor any of

the other local entities will assume liability for improper drainage design nor guarantee that the final drainage design review will absolve the developer or designer of future liability for improper design.

3. There are three levels of Storm Water Analysis and Drainage Plans: Conceptual Drainage Plan, Preliminary Drainage Plan, and Final Drainage Plan. A pre-submittal conference with Sandy City Public Utilities representatives is recommended to assist with defining the level of detail needed for the Storm Water Analysis and Drainage Plan.

**B. Conceptual Drainage Plan.**

1. At the conceptual level the following information shall be provided for review and approval prior to the development of a Preliminary Drainage Plan.
2. The Conceptual Storm Water Analysis Report shall provide the following information:
  - a) Title Page.
    - i. Project name, type of study, study date.
    - ii. Preparer's name and company.
  - b) Location.
    - i. City, County, State Highway and local streets within and adjacent to the site, or the area to be served by the drainage improvements.
    - ii. Major drainage ways and facilities.
    - iii. Names of surrounding developments.
    - iv. Names of receiving waters.
  - c) Existing Site Conditions and Proposed Project.
    - i. Existing grading and ground cover.
    - ii. Area in acres.
    - iii. Existing major irrigation facilities such as ditches and canals.
    - iv. Existing drainage patterns of the property and how offsite drainage flows.
    - v. Description of proposed project.
  - d) Design.
    - i. Conceptual level grading and drainage and how it fits existing drainage patterns and grading.
    - ii. Conceptual level proposed use of LID BMPs, retention, infiltration, and detention/outlet design.
    - iii. Conceptual level storm water treatment methods.
    - iv. Drainage problems including storm water quality and potential solutions at specific design points.
    - v. Post-construction stormwater management and BMPs for long-term control of storm water pollutants.
    - vi. Identification of potential impacts to public storm water system.

**Sandy City Corporation - Prod. 12/20**

3. The Conceptual Grading and Drainage Plan (electronic 24" x 36" in size) shall provide the following information:
  - a) Existing topography showing all existing drainage features within 100 feet (Public Utilities may increase this amount) of the project site including but not limited to: existing watercourses, storm drains, canals, irrigation ditches, springs, culverts, etc.
  - b) Any areas outside the project site that influence the project drainage infrastructure, upstream or downstream.
  - c) Conceptual plan for use of LID BMPs, storm water treatment facilities, detention/retention facilities, storm drains, and inlets.
  - d) Storm water discharge and overflow locations.
  - e) FEMA 100-year floodplain where required.
  - f) Draft Sandy City Floodplain Development Permit where required.
- C. Preliminary Drainage Plan.
  1. The purpose of the Preliminary Drainage Plan is to define at a feasibility level the nature of the proposed development or project and to describe existing conditions and to propose facilities needed to conform to the requirements of the Storm Water Design Criteria.
  2. At the preliminary level the following information shall be provided for review and approval prior to the development of a Final Drainage Plan.
  3. The Preliminary Storm Water Analysis Report shall provide the following information:
    - a) Title Page (See requirements for Conceptual Level Drainage Plan).
    - b) Location (See requirements for Conceptual Level Drainage Plan).
    - c) Existing Site Conditions and Proposed Project (See requirements for Conceptual Level Drainage Plan).
    - d) Design.
      - i. Preliminary level grading and drainage and how it fits existing drainage patterns and grading.
      - ii. Preliminary level proposed use of LID BMPs, retention, infiltration, and detention/outlet design.
      - iii. Identification as to whether the site is a high-use area and will require pre-treatment of storm water.
      - iv. Proposed storm water treatment methods.
      - v. Drainage problems including storm water quality and potential solutions at specific design points.
      - vi. Post-construction stormwater management and BMPs for long-term control of storm water pollutants.
      - vii. Identification of potential impacts to public storm water system.
      - viii. Specific details of the proposed storm water system and facilities (storm drains, manholes, inlets, LID BMPs, detention/retention facilities and structures, storm water treatment, etc.). This includes copies of BMP Fact Sheets for LID BMPs that will be implemented (see Section 7.09 – LID BMP Fact Sheets).



- e) Preliminary Level Storm Water Analysis: Provide summary of hydrologic and hydraulic analysis completed including methods, calculations, and processes.
  - i. Hydrologic Criteria.
    - a. Precipitation depths.
    - b. Design frequency.
    - c. Design storm distribution.
    - d. Sub-basin delineation and details.
    - e. Storm water modeling methods.
  - ii. Hydraulic Design and Calculations.
    - a. WQV.
    - b. Street design and drainage (gutter flow).
    - c. Storm drain inlets.
    - d. Storm drains.
    - e. Storm water control facilities and infiltration.
    - f. Water quality treatment devices.
    - g. Demonstration of 100-year 3-hour storm runoff overflow from site where necessary.
  
- 4. The Preliminary Grading and Drainage Plan (electronic 24" x 36" in size) shall provide the following information:
  - a) Existing topography showing all existing drainage features within 100 feet (Public Utilities may increase this amount) of the project site including but not limited to: existing watercourses, storm drains, canals, irrigation ditches, springs, culverts, etc.
  - b) Any areas outside the project site that influence the project drainage infrastructure, upstream or downstream.
  - c) Information required for existing and proposed utilities specified in 7.0 A – Public Utilities Standards and Requirements.
  - d) Preliminary design layout and details of storm water facilities including LID BMPs, storm water treatment facilities, detention/retention facilities, storm drains, inlets, combo boxes, junction boxes, water quality treatment devices, etc.
  - e) Preliminary design information for detention/retention facilities including:
    - i. Maximum water surface perimeter line and maximum water surface elevation (based on finish grades in the pond area).
    - ii. Peak volume.
    - iii. Side and bottom slopes.
    - iv. Discharge rate.
    - v. Vegetation.
    - vi. Outlet control structure details (size of orifice must be identified to

the nearest 1/8-inch).

- f) Storm water discharge and overflow locations.
- g) FEMA 100-year floodplain, label FIRM panel and date where required.
- h) Completed Floodplain Development Permit application (does not need to be approved at this stage) where required.

D. Final Drainage Plan

1. The purpose of the Final Drainage Plan is to define and expand the concepts shown in the Preliminary Drainage Plan and is sufficient of itself to assure conformance to the Storm Water Design Criteria.
2. At the final level the following information shall be provided for review and approval prior to final approval by Public Utilities.
3. The Final Storm Water Analysis Report shall provide the following information:
  - a) Title Page. (See requirements for Conceptual Level Drainage Plan)
    - i. Preparer's name, stamp, and signature.
  - b) Location. (See requirements for Conceptual Level Drainage Plan)
  - c) Existing Site Conditions and Proposed Project. (See requirements for Conceptual Level Drainage Plan)
  - d) Design.
    - i. Final level grading and drainage and how it fits existing drainage patterns and grading.
    - ii. Final level proposed use of LID BMPs, retention, infiltration, and detention/outlet design.
    - iii. Geotechnical investigation report including location of tests performed and recommended design infiltration rates where required.
    - iv. Identification as to whether or not the site is a high-use area and will require pre-treatment of storm water.
    - v. Storm water treatment methods.
    - vi. Drainage problems including storm water quality and potential solutions at specific design points.
    - vii. Post-construction stormwater management and BMPs for long-term control of storm water pollutants.
    - viii. Identification of potential impacts to public storm water system.
    - ix. Finalized details of the proposed storm water system and facilities (storm drains, manholes, inlets, LID BMPs, storm water treatment facilities, detention/retention facilities and structures, water quality treatment, etc.). This includes copies of BMP Fact Sheets for LID BMPs that will be implemented (see Section 7.09 – LID BMP Fact Sheets).
  - e) Final Level Storm Water Analysis: Provide summary of hydrologic and hydraulic analysis completed including methods, calculations, and processes.
    - i. Hydrologic Criteria.

- a. Precipitation depths.
      - b. Design frequency.
      - c. Design storm distribution.
      - d. Sub-basin delineation and details.
      - e. Storm water modeling methods.
    - ii. Hydraulic Design and Calculations.
      - a. WQV.
      - b. Street design and drainage (gutter flow).
      - c. Storm drain inlets.
      - d. Storm drains.
      - e. Storm water control facilities and infiltration.
      - f. Storm water treatment devices.
      - g. Demonstration of 100-year 3-hour storm runoff overflow from site where necessary.
4. The Final Grading and Drainage Plan (electronic 24" x 36" in size) shall provide the following information:
- a) Plan shall be stamped and signed.
  - b) Existing topography showing all existing drainage features within 100 feet (Public Utilities may increase this amount) of the project site including but not limited to: existing watercourses, storm drains, canals, irrigation ditches, springs, culverts, etc.
  - c) Any areas outside the project site that influence the project drainage infrastructure, upstream or downstream.
  - d) Information for existing and proposed utilities specified in 7.0 A – Public Utilities Standards and Requirements.
  - e) Final design layout and details of storm water facilities including LID BMPs, detention/retention facilities, storm drains, inlets, combo boxes, junction boxes, storm water treatment devices, etc.
  - f) Final design information for detention/retention facilities including:
    - i. Maximum water surface perimeter line and maximum water surface elevation (based on finish grades in the pond area).
    - ii. Peak volume.
    - iii. Side and bottom slopes.
    - iv. Discharge rate.
    - v. Vegetation.
    - vi. Outlet control structure details (size of orifice must be identified to the nearest 1/8-inch).

**Sandy City Corporation - Prod. 12/20**

- g) Plan and profile drawings where necessary.
- h) Storm water discharge and overflow locations.
- i) FEMA 100-year floodplain, label FIRM panel and date.
- j) Approved Sandy City Floodplain Development Permit where required.
- k) Approved Salt Lake County Flood Control Permit where required.
- l) Approved Utah Division of Water Rights Stream Alteration Permit where required.
- m) Confirmation of receipt from DEQ that the "Utah Underground Injection Control Program Inventory Information" for Class V injection wells where required.

7.09 **LID BMP FACT SHEETS**

- A. Following are fact sheets for the LID BMPs that are acceptable in Sandy City.

# BIORETENTION FEATURES

Bioretention areas are often shallow, landscaped areas that receive and treat stormwater. Runoff is allowed to pond on the surface of the bioretention area, typically a foot to 18 inches deep, where it can then filter through a vegetative layer and engineered soil media to remove sediment and pollutants. In locations of well drained subsoils, the water may then infiltrate into the subgrade. At sites or locations that will not allow for infiltration, flow-through systems are required; underdrains are installed beneath the planting soil to drain the facility and release the treated water to a conveyance feature or storm drain system. Bioretention areas are very versatile facilities that can fit a wide range of settings.



Bioretention areas are among the most common LID techniques implemented, often in highly visible locations, and can be a valuable educational opportunity especially if signage is installed illustrating function, intent, or native plants.

## Retrofit Opportunities



### Benefits

- Applicable to a wide range of sites and layout, easily integrated into urban retrofit projects
- Provides reliable water quality improvement and facilitates evapotranspiration
- Attenuates peak flows; reduces runoff volume and recharges groundwater when infiltration possible
- Provides greening and reduces heat island effect in urban areas
- Provides aesthetic amenity and creates habitat

### Potential Constraints

- Infiltration design requires sufficiently permeable soils, depth to groundwater/hardpan; underdrain system increases cost and maintenance
- Vegetation requires maintaining
- Vegetation will require dry season irrigation
- Ratio of Impervious to pervious shall not exceed 20:1; divide larger watersheds among dispersed features

### Siting Applications

- Residential yards
- Office and commercial store fronts
- Roadway medians, bulb-outs, and traffic circles
- Parking lot islands, cul-de-sacs
- Parks and other landscaped areas

## Technical Information

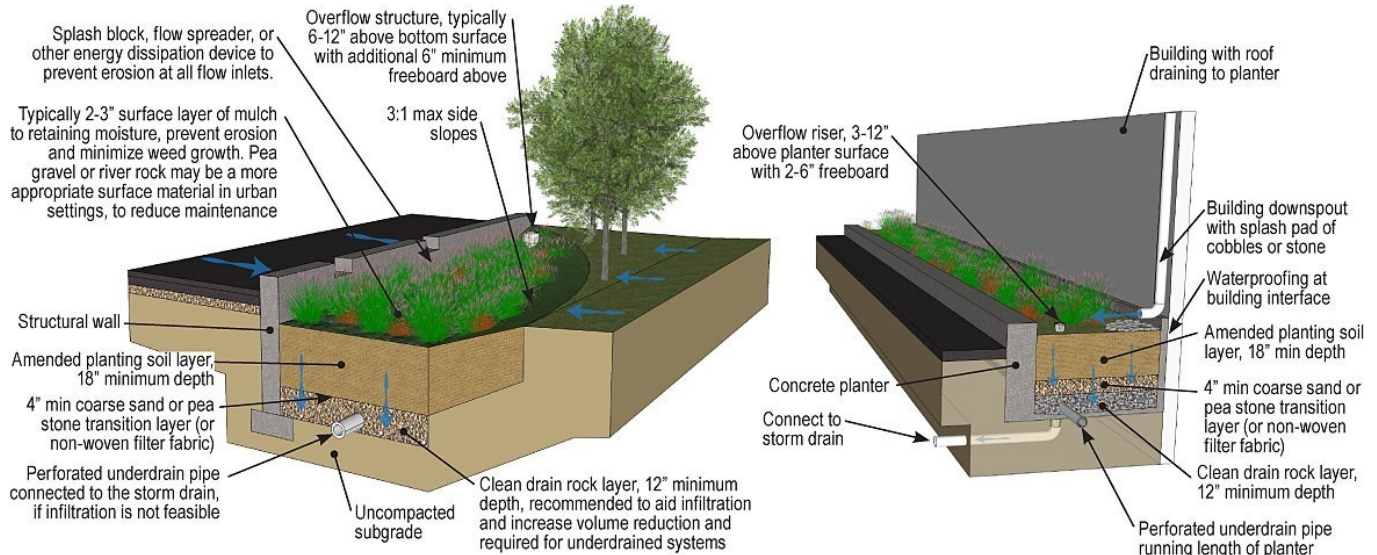

Figure: Bioretention feature typical details

## Design & Sizing Criteria

- Bioretention features are composed of an engineered media layer that is typically about 18" deep (to allow plant development) over an aggregate layer with a void ratio of approximately 40%, which provides subsurface storage volume. Increasing the depth of the storage gallery is a cost-effective way to increase performance of the bioretention area.
- Bioretention areas can be sized as either volume-based or flow-based systems (or a combination) to capture runoff from a contributing area much larger than the footprint.
- Volume-based systems are sized to capture the water quality volume within the surface ponding area and void space of the drain rock storage layer and should release all captured runoff within a maximum 48-hour drawdown time (either by subgrade infiltration or through an underdrain).
- Flow-based systems are sized to percolate the water quality flow through the bottom of the facility. The surface area of the system multiplied by the infiltration rate of the planting media (which should be considered as 5 in/hr. for design) must equal or exceed the water quality flow. The subgrade infiltration rate must be high enough to process this flow as well, or an underdrain is necessary.
- Reliance on subgrade infiltration requires a minimum soil infiltration rate of 0.5 in/hr., in addition to the above requirements. IF GI is planned for impermeable soils (HSG C and D), an underdrain should be installed.
- If the separation from the bottom of the facility to the seasonally high groundwater elevation is less than 10 feet then an underdrain should be installed, with an impermeable liner placed beneath all system media.
- Infiltrating bioretention systems should be placed a minimum of 10 feet from building foundations and 100 feet from drinking water wells. If located in an area with heavy traffic, use of structural curbs and tie-beams are recommended to ensure that any impact loads are distributed evenly.
- Pre-treatment (vegetated buffer strip, swale, sediment forebay) can improve function and ease maintenance.
- Portions of runoff from storms larger than the design storm may bypass the bioretention and be diverted to the storm drains system.



### Pollutant Removal

- Suspended pollution is removed by infiltration. Almost all solids are removed in the upper few inches of the soil surface.
- Dissolved pollution is removed by chemical precipitation or absorption to soil/media. Plant roots remove dissolved pollution by vegetation uptake.

### Water Quality Considerations

- Anoxic (low oxygen) conditions can remove some pollutants (nitrates) but also promote leaching (TP and organic matter).
- Soil or engineered media should have low phosphorus content.
- Bioretention with good drainage below the frost line will function in cold weather.
- Snowmelt infiltration with de-icing chemicals can contaminate groundwater and impact vegetation that is not salt tolerant.
- Bacteria can survive longer in the soil at low temperatures.
- Pollution removal is more effective at low influent concentrations.

### Performance

- Effective treatment for all pollutants except for influent high in phosphorus, which result in gain.
- Bioretention monitoring in Colorado shows less reduction compared to 2016 summary statistics except for TSS.
- USU monitoring in Logan and Salt Lake City has similar results as Colorado for phosphorus.

#### BIORETENTION MONITORING RESULTS FROM 2016 SUMMARY STATISTICS (WERF 2017)

	<b>E. COLI (cfu/100 ml)</b>	<b>TOTAL PHOSPHORUS (mg/L)</b>	<b>TOTAL NITROGEN (mg/L)</b>	<b>TOTAL SUSPENDED SOLIDS (mg/L)</b>
Inflow*	1200 (110-5900, n=7)	0.13 (0.12-0.17, n=30)	1.24 (0.77-2.25, n=17)	40.6 (18-99.2, n=25)
Outflow*	240 (18-1100, n=7)	0.13 (0.08-0.19, n=30)	1.04 (0.65-2.08, n=17)	10 (4-18.5, n=25)

\*Inflow and Outflow are median values (interquartile range, sample size).

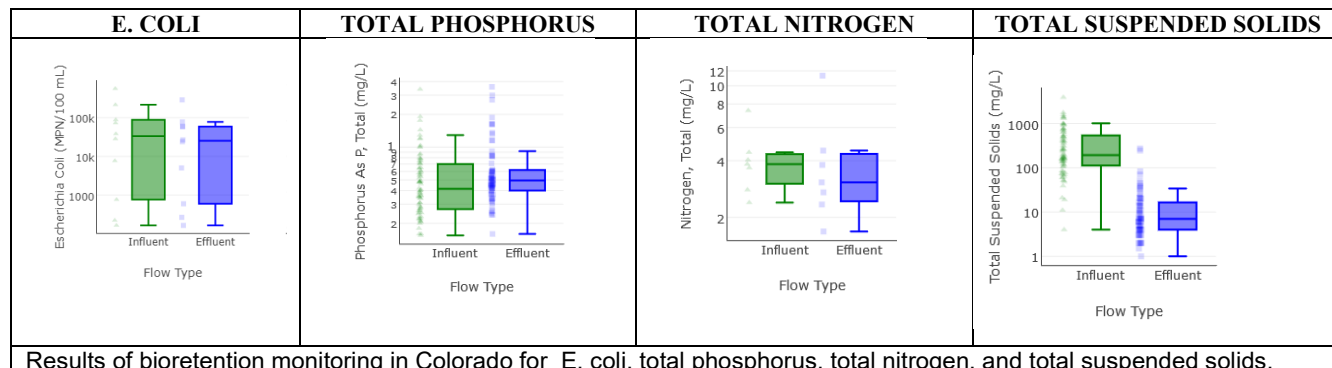

# PERMEABLE PAVEMENTS

Permeable pavement refers to any porous, load-bearing surface that allows direct rainfall and runoff to pass through the surface layer and be temporarily stored in a storage layer filled with aggregate. Ideally, site conditions will allow the subsurface storage layer to drain by infiltration into the subsoils or be released through an underdrain. The permeable pavement system itself will provide some water quality benefits by filtering sediments and some other pollutants. It will also reduce peak flows due to detention in the rock layer. Infiltration functions as the primary mechanism for stormwater treatment and volume reduction. Systems which use underdrains will provide reduced benefits such as peak flow mitigation. When properly constructed, porous pavements are durable, low maintenance, and have a low life-cycle cost.



Since they replace traditional hard surfaces, permeable pavement is easily integrated into developed areas. The wide variety of surface types provide diverse options for either matching or enhancing the character of an existing site.

## Retrofit Opportunities



### Benefits

- Reduces runoff volume and facilitates groundwater recharge (infiltration-based systems only)
- Easily integrated into existing infrastructure and retrofits
- Reduces the heat island effect and frequency/mass of salt application during winter
- Can be used as a designelement to provide aesthetic benefits
- Helps with peak flow attenuation
- Longer lifespan and lower lifecycle operations and maintenance cost compared to conventional paving
- Lack of ponding improves safety for pedestrians and cyclists

### Potential Constraints

- Not recommended for roads with high-speed traffic or frequent turning
- Construction costs can be greater than for conventional paving
- Will require additional maintenance when exposed to regular high-volume traffic
- Storage and infiltration are only effective on relatively flat sites with slopes less than 10%, as level subgrade must be achieved
- Likely not effective as a treatment method if infiltration to the subgrade is not an option
- Ratio of Impervious to pervious shall not exceed 5:1

### Siting Applications

- Parking lots or parallel parking strips or lanes
- Driveways and low traffic roads
- Sidewalks and pathways
- Golf cart paths
- Park hardscape
- Plazas, patios, or terraces
- Main arterial roads

## Technical Information

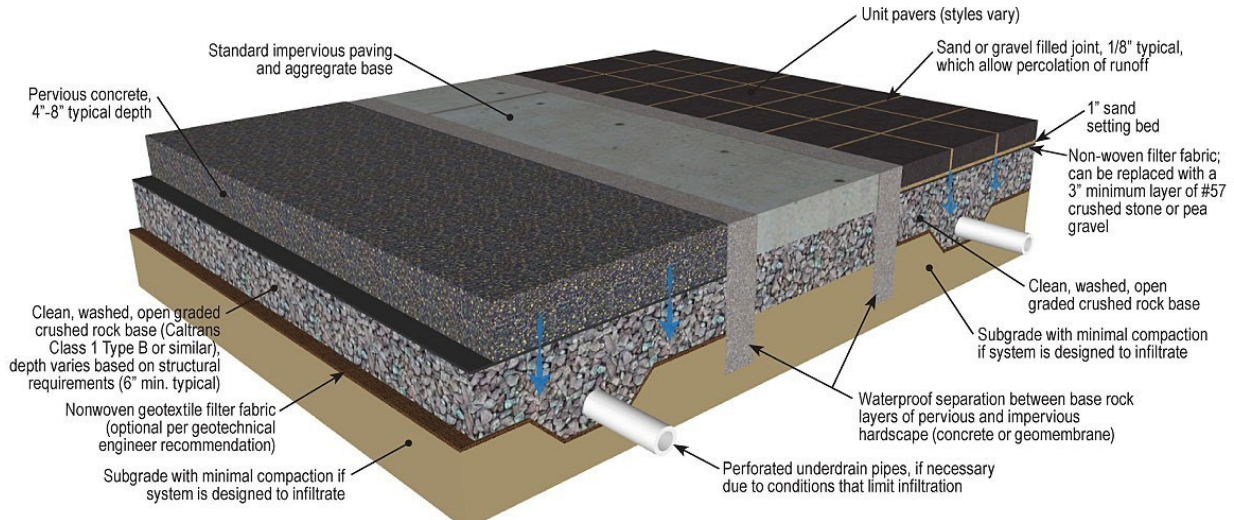

Figure: Pervious concrete and permeable pavers typical details

## Design & Sizing Criteria

- Permeable pavements are volume-based systems sized to capture stormwater runoff within the void space of the subsurface storage layer and should fully drain all stored runoff within a maximum 72-hour drawdown time.
- Infiltration-based systems (which provide treatment and volume reduction) must have a minimum subgrade soil infiltration rate of 0.5 in/hr.; underdrains should be used in impermeable soils (HSG C and D) that do not meet this standard. If infiltration exceeds 2.5 in/hr.
- Infiltration requires a minimum 10-foot separation between the bottom of the drain rock layer and the seasonally high groundwater elevation. For areas with inadequate separation or where the groundwater is contaminated, an underdrain should be used with an impermeable liner placed beneath the rock.
- Infiltration-based systems should be placed a minimum of 10 feet from building foundations and a minimum of 100 feet from drinking waterwells.
- Tributary areas should contribute runoff with low levels of sediment to avoid clogging the surface layer. If drainage will come from pervious or unstabilized areas, appropriate pre-treatment measures should be implemented to filter the runoff before reaching the permeable pavement.
- To ensure proper system function, it is essential that permeable pavements (especially poured in place systems) are installed properly by a contractor with prior experience and certification.

## Pavement Types

There are several types of permeable pavement available, including those that are poured in place (such as pervious concrete and porous asphalt) and modular paving systems (such as permeable interlocking concrete pavers, unit stone or brick pavers, or reinforced turf type systems).

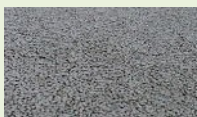

Pervious Concrete

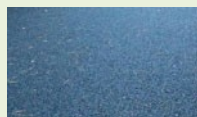

Porous Asphalt



Permeable Pavers



Reinforced Turf

### Pollutant Removal

- Filters and traps pollution in pavement pores and underlying base material.
- Bacteria in soil act as predators of coliform.
- Some cold weather studies indicate performance of permeable pavement is comparable to wetland ponds in regard to bacteria, nutrients, and sediment removal.

### Water Quality Considerations

- Maintains infiltration and treatment abilities during cold temperatures, resistant to freezing, thaws quickly.
- Best used in combination with other GI to pretreat influent water.
- Surface maintenance (i.e. sweeping) is critical to maintain perviousness and ability to remove pollution from runoff.
- Sweeping should occur monthly. Vacuuming and power washing should occur 2-3 / year.

### Performance

- Available data show effective treatment for TP and TSS.
- No influent data to measure performance for E. coli Median effluent is ~1,000 cfu and similar or lower than E. coli effluent measured from other GI, indicating reasonable treatment.
- Monitor results from Colorado monitor sites indicate better performance than 2016 summary statistics.

### PERMEABLE PAVEMENT MONITORING RESULTS FROM 2016 SUMMARY STATISTICS (WERF 2017)

	E. COLI (CFU/100 ML)	TOTAL PHOSPHORUS (MG/L)	TOTAL NITROGEN (MG/L)	TOTAL SUSPENDED SOLIDS (MG/L)
Inflow*	-	0.19 (0.12-0.36, n=8)	-	93.7 (36.8-243, n=9)
Outflow*	-	0.11 (0.07-0.2, n=8)	-	26 (15-53.2, n=9)

\*Inflow and Outflow are median values (interquartile range, sample size).

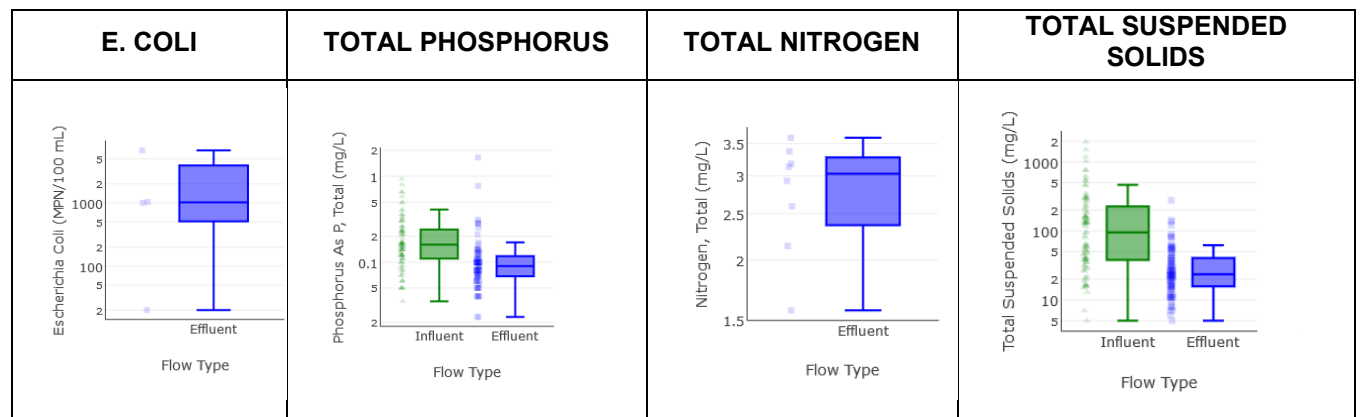

Results of permeable pavements monitoring in Colorado for E. coli, total phosphorus, total nitrogen, and total suspended solids.



# WETLANDS, DRY OR WET PONDS

Constructed wetlands are man-made systems that typically have multiple shallow permanent pools of water at varying depths, incorporating both emergent wetland plants and open water areas. Though possessing less biodiversity than natural wetlands, they still offer significant habitat enhancement and aesthetic value while being optimized for stormwater treatment. These facilities are among the most effective at removing pollutants from stormwater. Constructed wetlands provide water quality benefits through settling, microbial transformation, and plant uptake. Treatment primarily occurs in the root zone and soil media, where nutrients and dissolved pollutants are removed.



Though more technically complex, constructed wetlands have the potential to provide the most water quality improvements of any naturalized system.

## Retrofit Opportunities



## Benefits

- Effective at removing a broad spectrum of pollutants commonly found in urban runoff
- Reduces stormwater peakflows
- Provides substantial habitat
- Attractive landscape feature, well suited as an open-space amenity
- Good in areas unsuitable for infiltration or with high groundwater table
- Easily customizable to various sizes and dimensions, based on site, budget, and design intent

## Potential Constraints

- Space requirement
- Standing water may represent safety concern
- Mosquito breeding is likely to occur, requiring vector control
- Cannot be placed on steep or unstable slopes
- Base flow or supplemental water source needed in dry season if water level is to be maintained
- Possible aesthetic concerns related to vegetation appearing dead or unkempt in winter and summer
- Ratio of Impervious to pervious shall not exceed 20:1;

## Siting Applications

- Parks, open spaces, and golf courses
- Commercial, industrial, or residential developments
- Regional detention & treatment

## Design Variation

A subsurface flow wetland has no open water and runoff is directed beneath the surface through a planted substrate. They generally require less surface area and have fewer vector issues but may be more expensive to construct and maintain.

## Technical Information

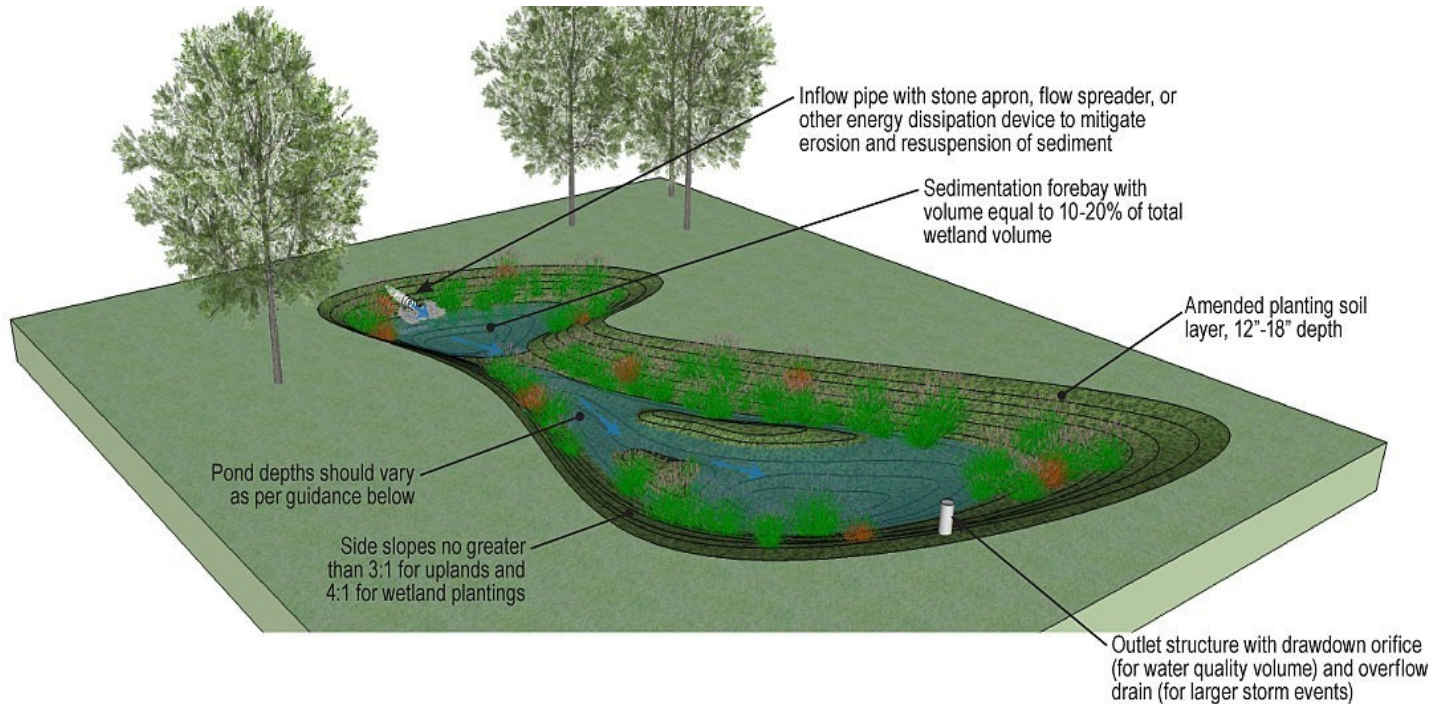
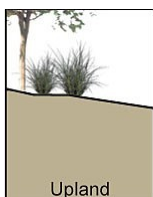

Figure: Constructed wetland typical detail

## Design & Sizing Criteria

- Constructed wetlands are volume-based systems sized to capture the water quality volume and discharge it from the outlet within 24 hours.
- The health of wetland vegetation is integral to the ability of stormwater wetlands to improve water quality. Wetlands should have zones of both very shallow (less than 6 inches) and moderately shallow (6 to 18 inches) standing water to maintain both vegetated and open water areas, with maximum depths of about 5 feet.
- To enhance pollutant removal, wetlands should feature "complex microtopography" in which the underwater surface varies in elevation to increase the length of flow paths for runoff.
- The minimum length to width ratio should be 2:1, though 4:1 is preferred.
- Open water should occupy 25-50% of the surface.
- Pre-treatment, which occurs via settling in a forebay, will greatly aid the function of constructed wetlands. Additional upstream BMPs may also be used to enhance treatment effectiveness.
- Stormwater wetlands require a large contributing area to maintain a permanent pool, typically at least 5 acres.
- In areas with well-draining soils (HSG A or B) an impermeable liner and/or a larger contributing area may be necessary to maintain standing water.
- Wetlands may intersect the groundwater table, which will help maintain the permanent pool. This should be avoided in areas where stormwater or the groundwater may be contaminated. In these areas, an impermeable liner should be utilized.

## Plant Selection (See Appendix A)



-Edge & small islands  
-3:1 max side slope  
-Inundated by runoff

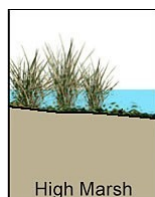

-Water depth ≤ 6"  
-4:1 max side slope  
-May dry in summer

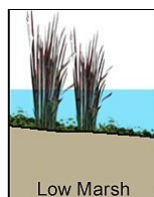

-Water depth 6"-18"  
-5:1 max side slope  
-Emergent plants

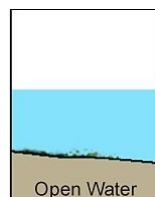

-Water depth ≤ 5'  
-25-50% of total area

## Plant Selection

Wetlands, with their variety of water depths and topography, will require a more diverse and extensive plant palette than other BMPs. Most locations will require plants suitable for prolonged standing water and, due to the permanent pool, it is also acceptable to use plants with higher irrigation demand.



### Pollutant Removal

- Particle settling and sedimentation.
- Chemical processes that precipitate nutrients and other pollution.
- Biological uptake by plants, algae, and bacteria.

### Water Quality Considerations

- Standing water can provide opportunity for algae growth, decomposition, and anoxic conditions.
- Wetlands can provide more water quality benefits compared to any other natural water feature.
- Ability to remove pollution decreases during the winter season in Utah.

### Performance

- Results show water quality benefits for all parameters, including substantial reductions for E. coli and total suspended solids.
- No influent E. coli measurements available for Colorado sites. Median value of effluent is below recreational standard in Utah

### WETLANDS/WET DRY POND MONITORING RESULTS FROM 2016 SUMMARY STATISTICS (WERF 2017)

	<b>E. Coli (cfu/100 ml)</b>	<b>Total Phosphorus (mg/L)</b>	<b>Total Nitrogen (mg/L)</b>	<b>Total Suspended Solids (mg/L)</b>
<b>Inflow*</b>	2800 (650-15000, n=10)	0.16 (0.1-0.27, n=75)	1.48 (1.02-2, n=37)	31 (13.1-75.9, n=78)
<b>Outflow*</b>	1000 (260-3800, n=10)	0.12 (0.07-0.22, n=75)	1.42 (1.02-1.82, n=37)	14.1 (4.7-31, n=78)

\*Inflow and Outflow are median values (interquartile range, sample size).

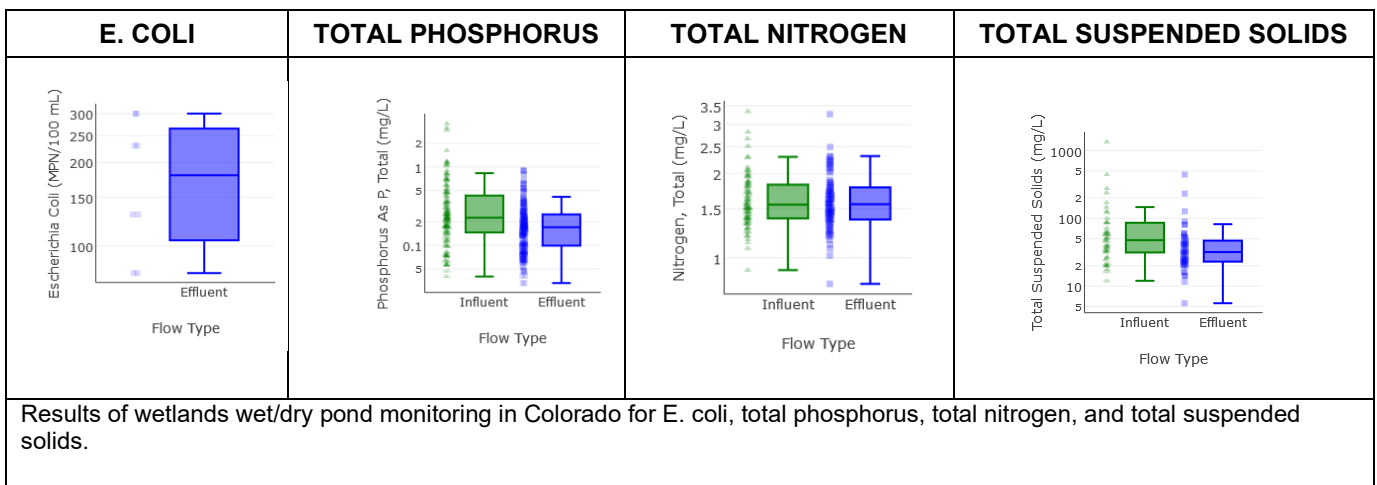

# VEGETATED SWALES

Vegetated swales are shallow stormwater conveyance channels with vegetation covering the side slopes and bottom. Treatment occurs as runoff flows through the vegetation and infiltrates into the soil. Swales can be designed as part of stormwater conveyance system and can eliminate the need for some curbs, gutters and storm drains, while providing onsite treatment from road runoff. They are also well suited to treat runoff from roads and highways because of their linear nature. The treatment effectiveness is correlated to the residence time of the runoff in the swale, and therefore, flow-based swales tend to be considerably longer than other types of treatment BMPs.



Vegetated swales, such as this installed in a parking lot, can both treat and convey runoff, eliminating the need for some catch basins and pipes.

## Retrofit Opportunities



### Benefits

- Can convey stormwater, including within street right-of-way
- Low installation and maintenance costs
- Reduces peak flows and velocity compared to concrete lined or piped conveyance
- Improves water quality, depending on site constraints, by removing sediment, suspended solids, and trace metals
- Vegetation provides aesthetic benefit and reduces the heat island effect in urban areas

### Potential Constraints

- Larger space requirements than traditional conveyance methods
- Requires regular vegetative maintenance and trash removal
- Can be difficult to locate in retrofit applications
- Not suitable for areas with steep slopes or highly erodible soils
- Limited to relatively small drainage areas, generally less than 5 acres
- Limited volume reduction and peak flow attenuation, unless designed with check dams
- Need protection from salt and sand application during the winter

### Siting Applications

- Road shoulders and medians
- Parking lot islands
- Commercial, industrial, and residential developments
- Open space and parks

## Technical Information

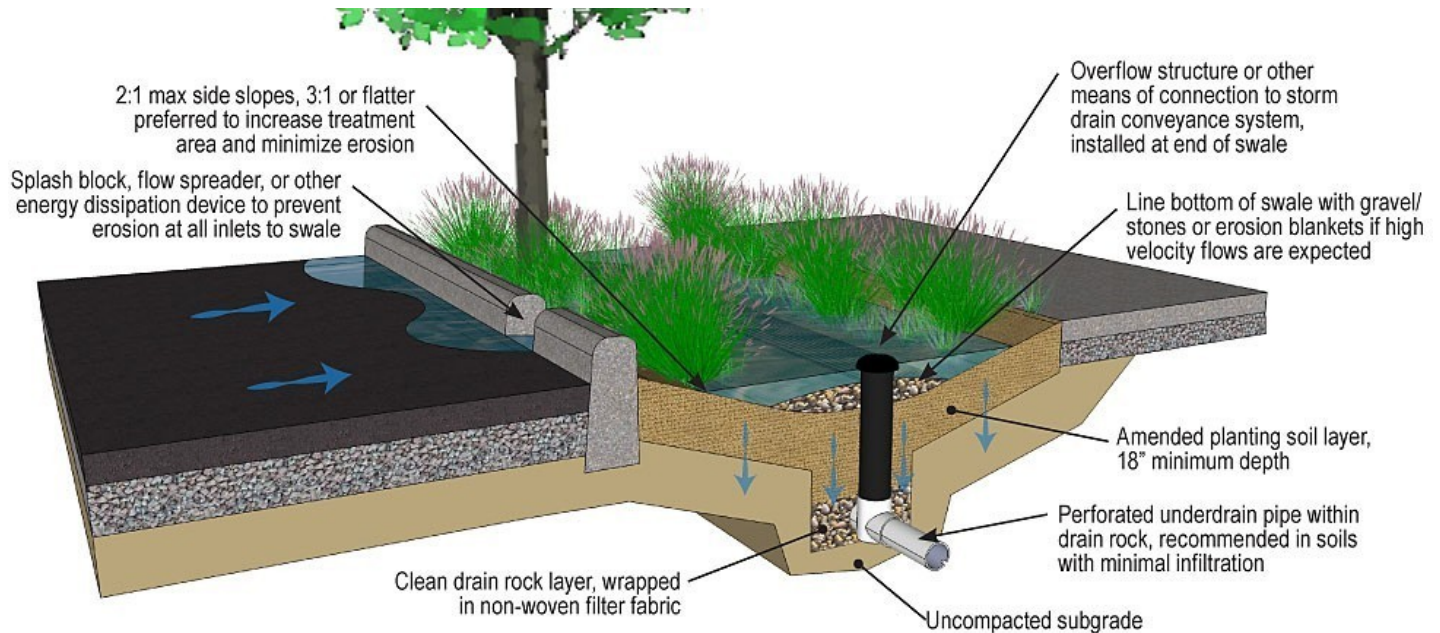

Figure: Vegetated swale typical detail

## Design & Sizing Criteria

- Swales are flow-based systems sized to convey the stormwater runoff at a flow velocity not exceeding 1 foot per second and maximum water depth not exceeding the lesser of 6 inches or 2/3 of the vegetation height.
- Swales must provide a minimum of 10 minutes of stormwater residence time for pollutant removal, with a minimum length of 100 feet.
- The preferred longitudinal slope is 1-2% to limit flow velocity. Check dams placed across the flow path can promote additional infiltration and flow reduction and should be used for longitudinal slopes exceeding 5%.
- Swales should generally have a trapezoidal or parabolic shape to promote even flow across the whole width of the swale. The bottom width should be between 2 and 10 feet.
- A dense and well-maintained vegetative cover on the swale bottom and side slopes filters pollutants out of runoff and helps reduce flow velocities and protect the swale from erosion. Stones or gravel may also be used on the bottom to protect against erosion.
- Vegetated swales that are primarily designed to detain runoff (behind check dams or due to layout) should be considered bioretention facilities and designed accordingly.
- Most effective on soils that allow infiltration. In impermeable soils, installing well-drained planting media with an underdrain beneath is recommended.

### Pollutant Removal

- Vegetation traps suspended particles and promotes infiltration.
- Deposition of solid particles to the soil surface.
- Plant roots remove dissolved pollution by vegetation uptake.

### Water Quality Considerations

- Filtering capacity of pollution is influenced by surface slope and maintaining vegetation cover.
- Soil properties must be conducive to vegetation growth and infiltration.
- Dense vegetation is ideal but must thrive in Utah. Vegetation should be taller than peak flow depth.
- Create maximum exposure to vegetation without impounding flow.

### Performance

- Available data show increase in pollution for most parameters.
- Summary stats show removal of TSS is less at low concentrations (25<sup>th</sup> percentile) and increases for median-higher concentrations.
- Monitor results from Colorado show substantial decrease in TSS.

### BIO SWALE MONITORING RESULTS FROM 2016 SUMMARY STATISTICS (WERF 2017)

	<b>E. COLI (CFU/100 ML)</b>	<b>TOTAL PHOSPHORUS (MG/L)</b>	<b>TOTAL NITROGEN (MG/L)</b>	<b>TOTAL SUSPENDED SOLIDS (MG/L)</b>
Inflow*	3500 (410-11000, n=5)	0.12 (0.07-0.25, n=23)	0.76 (0.44-1.5, n=8)	28.6 (9.2-67.5, n=24)
Outflow*	4400 (1200-11000, n=6)	0.2 (0.11-0.29, n=23)	0.85 (0.54-1.6, n=8)	24 (11-46.7, n=24)

\*Inflow and Outflow are median values (interquartile range, sample size).

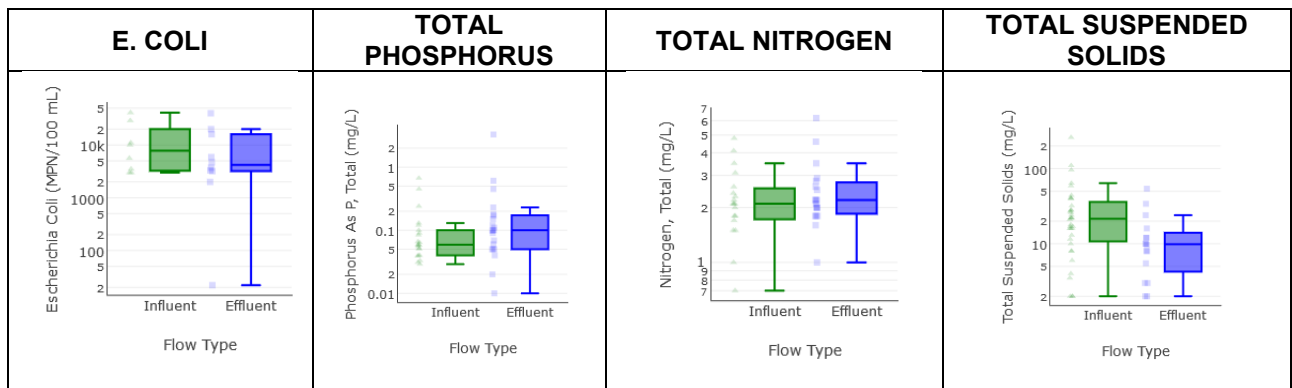

Results of swale monitoring in California for total phosphorus and total suspended solids. Total nitrogen monitoring from Texas. E coli monitoring from Oregon.



# UNDERGROUND DETENTION & INFILTRATION SYSTEMS

Designed and constructed as surface or subsurface features, detention/infiltration basins capture and control discharge of stormwater. These systems can remove pollutants by using sediment traps and filtering through the underlying soils. An infiltration trench is a long, narrow, rock-filled trench with no outlet that receives stormwater runoff from contributing areas. A dry well is a small rock-filled pit that usually receives runoff from rooftops or other impervious areas with low sediment loading. Water is stored in the void space between the stones and percolates through the underlying soil matrix. If high sediment loads are expected, pretreatment is desirable to reduce the maintenance burden.



Underground infiltration systems can be integrated into a site to enhance and diversify the landscaping, in addition to providing stormwater improvements.

## Retrofit Opportunities

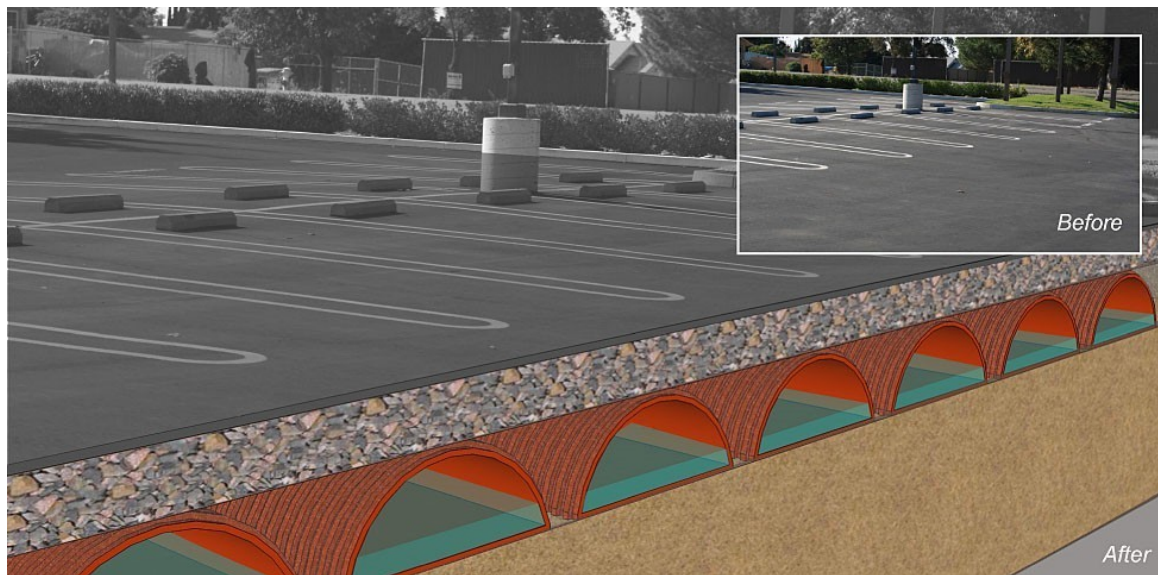

### Benefits

- Reduces runoff volume and attenuates peak flows
- Improves water quality - good for removing fine sediment and adsorbed pollutants
- Enhances groundwater recharge and contributes to stream base flow
- Minimal surface space requirements; located underground and thus visually unobtrusive
- Low construction and maintenance costs

### Potential Constraints

- Requires permeable subgrade soils, not recommended for HSGs Types C or D
- Requires groundwater separation
- Contributing area should generally be less than 5 acres
- Not suitable on fill sites, steep slopes (>15%), contaminated soils, industrial sites, or sites where spills are likely to occur
- May encounter siting challenges in urban retrofit areas due to foundation setback, utilities, and poor soil conditions
- Liquefiable soils would require additional improvements

### Siting Applications

- Mixed-use and commercial
- Roads and parking lots
- Parks and open spaces
- Single and multi-family residential



## Technical Information

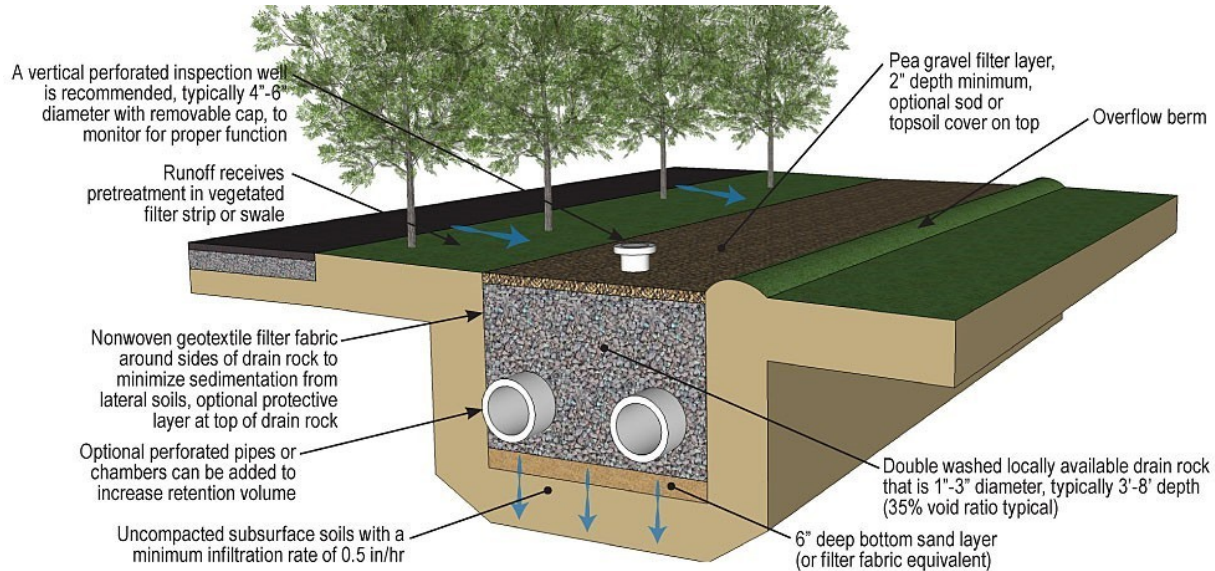

Figure: Infiltration trench typical detail

## Design & Sizing Criteria

- Detention and infiltration facilities are volume-based systems sized to capture the water quality volume within the void space of the storage layer and should infiltrate all stored runoff into the subsoils within a maximum 72-hour drawdown time.
- Likely require a box-like concrete structure, which provides a void ratio of 90% (at a higher cost) or storage galleries that provide a void ratio of approximately 40% (at a lower cost).
- Requires a minimum subgrade soil infiltration rate of 0.5 in/hr. minimum. If soil infiltration rates exceed 2.5 in/hr., runoff should be fully treated (with one or more upstream BMPs) prior to infiltration to protect groundwater quality.
- Requires a 10-foot minimum separation from the bottom of the facility to the seasonally high groundwater elevation.
- Should be placed a minimum of 10 feet from building foundations and 100 feet from drinking water wells.
- Should be installed with a flat bottom to promote uniform infiltration.
- To help prevent clogging and ease maintenance, it is important to provide upstream pre-treatment (using filter strips, swales, forebays, or manhole sumps) to remove coarse sediment, particles, and oils.
- If possible, system should be designed to avoid classification as a Class V injection well, which requires submission of an inventory form to the EPA. A Class V injection well is deeper than it is wide.
- If infiltration is not possible, can be installed with an orifice to provide flow and volume control functions without any water quality treatment.

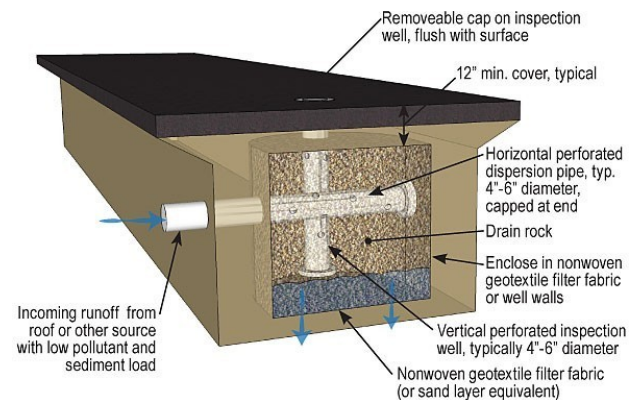

Figure: Dry well typical detail

## Proprietary Systems

There are many retention systems designed to maximize subsurface capture volume and that include components for pretreatment and flow control.



*Cudo Cubes are an example of a typical modular block system.*



*Triton stormwater chambers are a typical semi-circular linked chamber system.*

Note: Proprietary systems are included for representative purposes only and are not an endorsement of any specific product.

### Pollutant Removal

- Underground Storage Systems (USS) settle suspended pollution as runoff collects.

### Water Quality Considerations

- USS are not exposed to sunlight and diel cycles of temperature and DO.
- Stratification can produce low DO due to OM accumulation and decomposition.
- Decreased temperatures between inflow and outflow.

### Performance

- Effective removal of nutrients at median concentrations, less effective at low concentrations.
- High removal of suspended solids.

- Infiltration in some USS designs can further remove pollution through adsorption.

- Sedimentation can reduce infiltration and water quality performance.
- Few water quality studies are available for USS. Estimating water quality benefits should be made conservatively.

### UNDERGROUND STORAGE (INFILTRATION BASIN) MONITORING RESULTS FROM 2016 SUMMARY STATISTICS (ISW DATABASE QUERY – AUGUST 2019)

	E. COLI (CFU/100 ML)	TOTAL PHOSPHORUS (MG/L)	TOTAL NITROGEN (MG/L)	TOTAL SUSPENDED SOLIDS (MG/L)
Inflow*	0	0.471 (0.281-0.906, n=3)	2.28 (1.2-2.4, n=2)	38.5 (20-92.7, n=3)
Outflow*	0	0.38 (0.275-1.05, n=3)	1.2 (1.05-1.65, n=2)	20.1 (6.01-49, n=3)

\*Inflow and Outflow are median values (interquartile range, sample size).

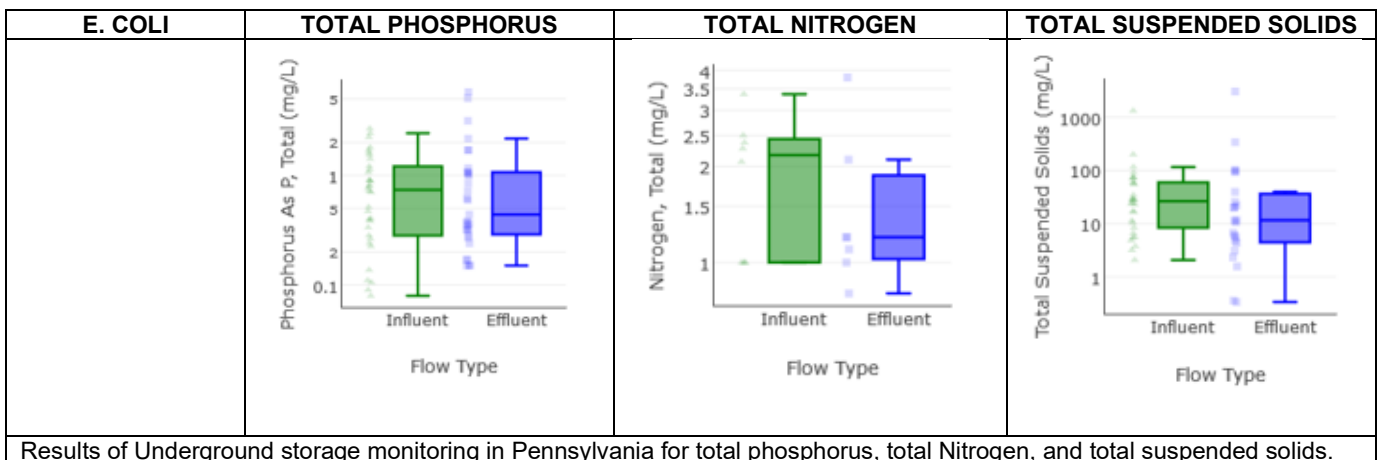

# VEGETATED STRIPS

Filter strips are vegetated surfaces that are designed to treat sheet flow from adjacent surfaces. Filter strips function by slowing runoff velocities and allowing sediment and other pollutants to settle and by providing some infiltration into underlying soils. Filter strips are most effective when runoff passes over the filter surface as shallow, uniform sheet flow. They can suffer erosion and lack of treatment if exposed to concentrated flows. They are well suited to treat runoff from adjacent roads or small parking areas and are good for use as vegetated buffers between developed areas and natural drainages.



Filter strips can be as simple as a gentle slope covered in grass that receives runoff from an adjacent strip of parking stalls.

## Retrofit Opportunities



### Benefits

- Low construction cost and minimal maintenance requirements (erosion prevention)
- Can provide reliable water quality benefits if properly designed, vegetated, and maintained
- Good for roadside shoulders and landscape buffers when slope and length criteria are met
- Simple, aesthetically pleasing landscape features
- Easy to customize to varying site conditions

### Potential Constraints

- Not appropriate for industrial sites or locations where spills may occur
- Limited ability to treat large drainage areas
- Water quality benefits severely limited without adequate filter length and flow characteristics
- Does not provide significant stormwater volume reduction
- Only minor reduction in flow rate, especially during larger storms
- May require seasonal irrigation
- Needs reduced salt and sand application during winter months

### Siting Applications

- Roads and highway shoulders
- Small parking lots
- Residential, commercial, or institutional landscaping
- Pre-treatment component for subsequent BMP



## Technical Information

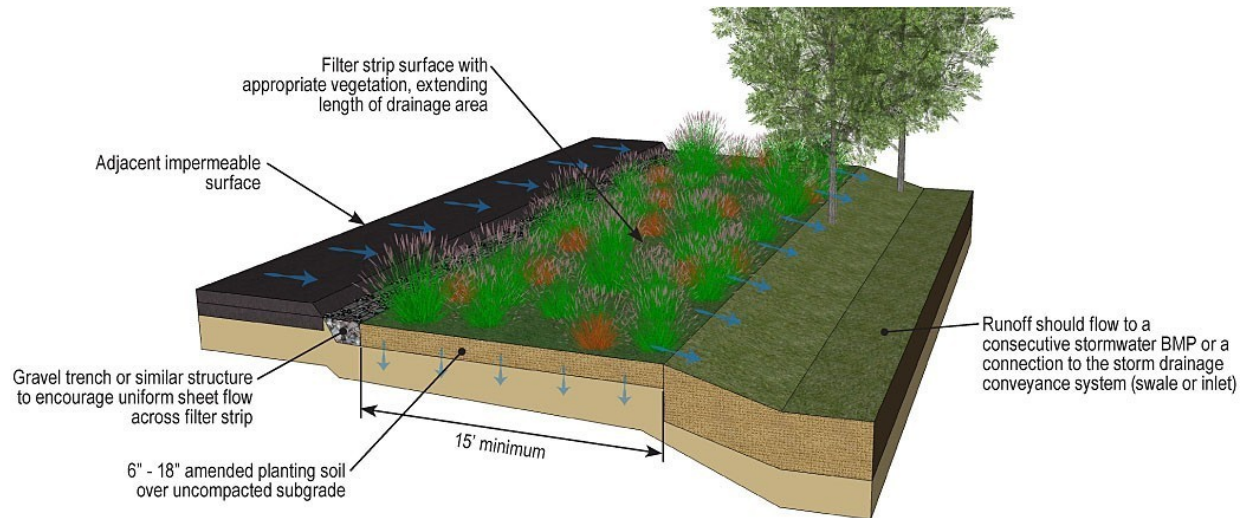

Figure: Filter strip typical detail

### Design & Sizing Criteria

- Filter strips are flow-based systems designed to convey the water quality flow across the vegetated surface at a flow velocity not exceeding 1 foot per second and maximum water depth not exceeding 1 inch.
- Should be at least 15 feet wide and preferably 25 feet wide (in the direction of flow) to provide adequate water quality treatment.
- Filter strips are considered effective at treating contributing impervious surface widths up to twice the width of the vegetated strip. The maximum length (in the direction of flow towards the filter strip) of the contributing tributary area should be 60 feet.
- Should be immediately adjacent to, and extend the full length of, the contributing drainage area.
- Ideal cross-slope is between 2% and 6% to avoid ponding (at low slopes) and concentrated flows (at high slopes). Slopes up to 15% may be acceptable with proper design and careful maintenance but are generally not recommended.
- If the cross-slope is less than 0.50%, or if the underlying soil infiltration rate is less than 0.5 in/hr., consider an underdrain system to facilitate drainage.
- Requires shallow, evenly-distributed sheet flow across the entire width of the strip. Level slopes perpendicular to the direction of flow are required to achieve sheet flow.
- A level spreading feature such as a gravel trench may help promote sheet flow, however if used it must be carefully maintained.

### Pollutant Removal

- Removes sediment and other suspended particles from runoff.
- Dissolved nutrients are removed from runoff through infiltration, plant uptake and adsorption to soil particles.
- Promotes degradation and transformation of pollutants.

### Water quality considerations

- Use to pretreat runoff and remove large material before sending to other GI for more improvements to water quality.
- Surface runoff must stay in sheet flow to receive proper water quality treatment.
- Use for snow storage in winter months. Be aware of salinity impacts.
- Similar to other GI with vegetation, a dense cover of plants that thrive in Utah will result in maximum performance.

### Performance

- The 2016 summary statistics show effective treatment for total nitrogen and total suspended solids.
- No monitor sites available in Colorado.
- Monitoring near Austin, Texas shows positive results for removing total phosphorus and total suspended solids from stormwater.

### VEGETATED STRIPS MONITORING RESULTS FROM 2016 SUMMARY STATISTICS (WERF 2017)

	E. COLI (CFU/100 ML)	TOTAL PHOSPHORUS (MG/L)	TOTAL NITROGEN (MG/L)	TOTAL SUSPENDED SOLIDS (MG/L)
Inflow*	-	0.14 (0.08-0.25, n=19)	1.4 (0.8-2.04, n=8)	44 (20-90, n=19)
Outflow*	-	0.17 (0.1-0.34, n=19)	1.13 (0.8-1.55, n=8)	19 (10-35, n=19)

\*Inflow and Outflow are median values (interquartile range, sample size).

E. COLI	TOTAL PHOSPHORUS	TOTAL NITROGEN	TOTAL SUSPENDED SOLIDS
No data.			
Results of vegetated strip monitoring near Austin, Texas for E. coli, total phosphorus, total nitrogen, and total suspended solids.			



# VEGETATED BASIN

Vegetated basins are temporary holding areas for stormwater that capture and detain flows from a design storm for some minimum time (e.g. 48 hours) to allow suspended solids and associated pollutants to settle. They are typically designed with an outlet structure that slowly releases the water requiring treatment via a small orifice and allows controlled routing of larger events. Water quality drawdown can be achieved through infiltration, if site conditions will allow. Stormwater collected in vegetated basins can be re-used for landscape irrigation, and basins can also be used to provide flood control by including additional flood detention storage.



Basins that are thoughtfully designed and planted can manage stormwater from a larger area, while still offering aesthetic appeal.

## Retrofit Opportunities



### Benefits

- Relatively low construction and maintenance costs
- Highly effective at attenuating peak flows, can reduce runoff volumes with infiltration or reuse
- Improves water quality by removing particulate matter, sediment, trash, and debris
- Suitable for sites where infiltration is poor or not an option
- Suitable for large drainage areas
- Multi-purpose detention ponds can provide open space, habitat, and aesthetic amenity

### Potential Constraints

- Limitations of the release orifice may not allow use of detention in watersheds of less than 5 acres (would require an orifice with a diameter of less than 0.5 inches that would be prone to clogging)
- Only moderate pollutant removal compared to some other BMPs and ineffective at removing soluble pollutants
- May exhibit undesirable aesthetics due to dry, bare areas and inlet and outlet structures
- Site must have no risk of land slippage if soils are saturated

### Siting Applications

- Parks, open spaces, and golf courses
- Commercial, industrial, or residential developments
- Regional detention & treatment

### Design Variation

A basin designed with a permanent pool is commonly referred to as a wet pond; additional treatment and amenity benefits can be realized by the body of water, along with maintenance and the need for base flow or supplemental water.

## Technical Information

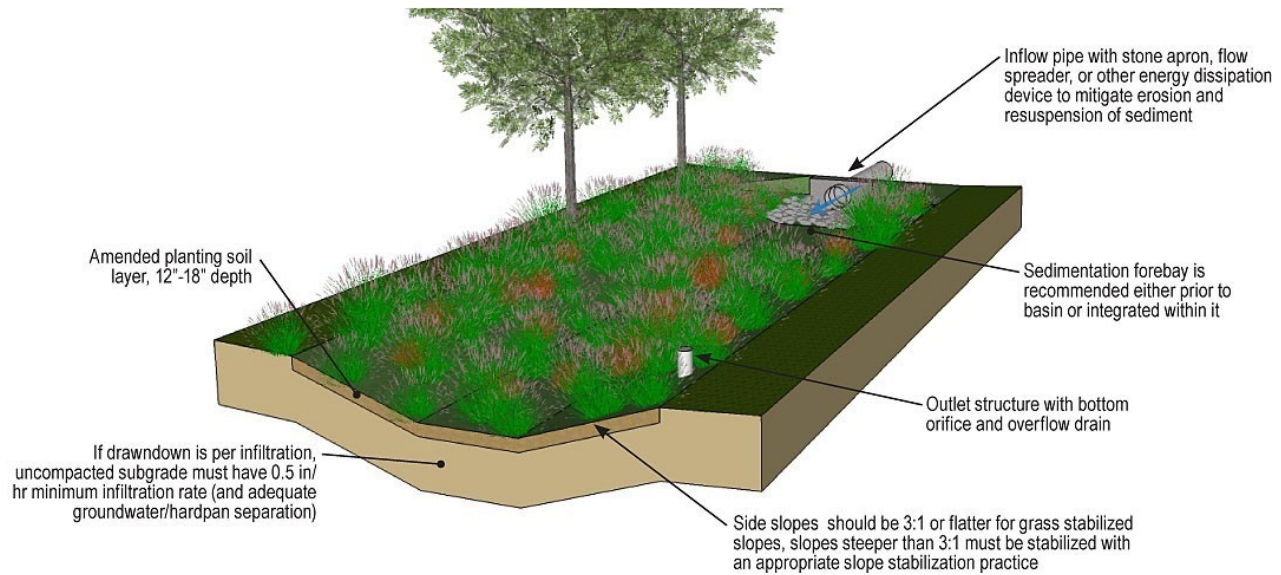

Figure: Vegetated basin typical detail

## Design & Sizing Criteria

- Vegetated basins are volume-based systems sized to capture the water quality volume and discharge it within a typical 48-hour drawdown time, with no more than 50% of the total volume draining in the first 16 hours.
- Longer drawdown times may result in vector breeding and should be used only after coordination with local vector control authorities. Shorter times should be limited to BMP drainage areas with coarse soils that readily settle or where infiltration is responsible for the majority of drawdown.
- A length to width ratio of at least 1.5:1 (and ideally 3:1) is recommended for greatest treatment capability (due to a longer flow path).
- A reinforced channel from inlet to outlet can be included to convey low flows through the basin.
- Maintenance can be reduced if runoff passes through upstream filtration BMPs or a sedimentation forebay prior to entering the basin.
- Outlet structure(s) include an orifice (and/or infiltration) for drawdown, an overflow drain for storms greater than the design storm, and an emergency spillway/drain for large flood events.
- If the separation from the bottom of the facility to the seasonally high groundwater elevation is less than 10 feet, the facility should be lined with impermeable liner (compacted native clay or geomembrane).
- If sufficient space is available, a vegetated buffer around the pond can be used to slow overland runoff entering via the side slopes, help prevent access to the pond if desired, and provide an aesthetic and habitat amenity.

### Pollutant removal

- Remove pollution through settling and possibly infiltration if site conditions allow.
- Not very effective at removing dissolved pollution. Vegetation uptake can occur but minimal.

- Can remove coarse suspended material (e.g. branches, trash, etc.) due to restricted outflow.
- Can reduce downstream erosion by reducing magnitude and timing of peak flow

### Water Quality Considerations

- Need regular maintenance to keep outlet clear and ensure proper function.
- Dead vegetation in basin should be disposed of to reduce OM loading to downstream waters.

- Remove all clippings from basin if vegetation is mowed.

### Performance

- Effective removal for all pollutants except for nitrogen. Positive results for nitrogen at monitored sites in Texas.
- High removal for E. coli at low concentrations, and TSS for all concentrations.

## VEGETATION BASIN (DETENTION BASIN) MONITORING RESULTS FROM 2016 SUMMARY STATISTICS (WERF 2017)

	E. COLI (CFU/100 ML)	TOTAL PHOSPHORUS (MG/L)	TOTAL NITROGEN (MG/L)	TOTAL SUSPENDED SOLIDS (MG/L)
Inflow*	0	0.23 (0.14-0.38, n=31)	1.15 (0.79-1.7, n=15)	68 (24.1-129, n=32)
Outflow*	0	0.19 (0.11-0.3, n=31)	1.19 (0.74-2.1, n=15)	24.3 (10.5-49.6, n=33)

\*Inflow and Outflow are median values (interquartile range, sample size).

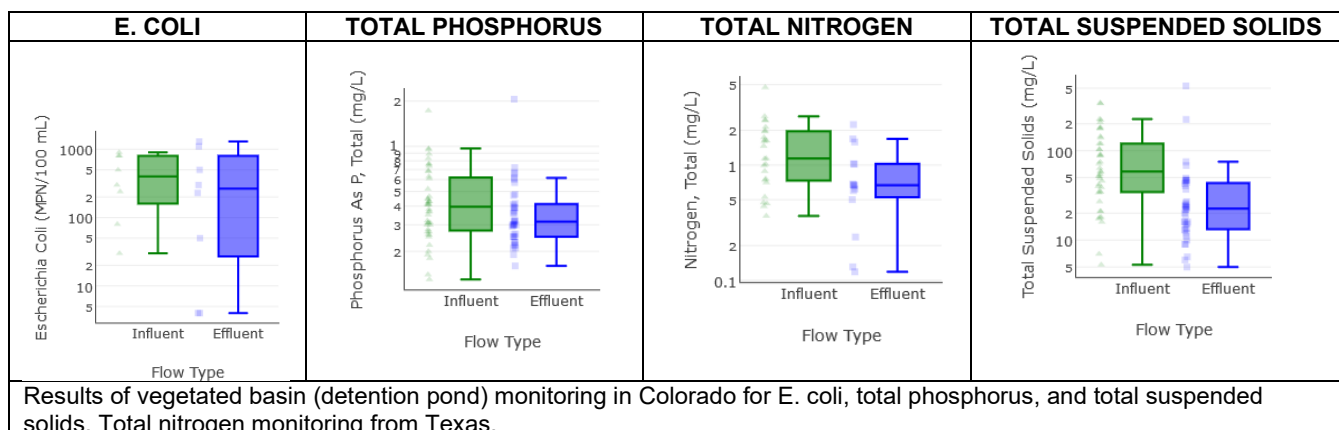



# GREEN ROOF

A green roof is a vegetated system covering a building's roof that detains and filters direct rainfall. Stormwater is captured in the soil media and storage layers of the system, reducing peak storm flows and promoting evapotranspiration. A primary water quality benefit of green roofs is that they avoid the common pollutants associated with conventional roof runoff, instead releasing only rainwater that has been further filtered. Green roofs can be designed with minimal thickness to allow retrofit installation on existing buildings or with a mix of shrubs, trees, pathways, and benches to be a valuable amenity for building tenants and the public.



Green roofs are unique stormwater features which also provide a variety of diverse benefits to building systems as well as inhabitants and users.

## Application Examples



*Extensive green roof*



*Intensive green roof*

## Benefits

- Reduces the peak discharge rate by slowing down roof runoff
- Enhances site aesthetics and can provide a useable amenity or public space
- Creates habitat and increases vegetation, even in densely developed areas
- Can extend the life of the roof, compared to a conventional roof
- Reduces heat island effect and improves air quality
- Provides insulation, which reduces building energy use

## Potential Constraints

- Not ideal for steep roofs (>20 degrees)
- Only manages rooftop runoff
- Greater roof weight may increase dead and live loads and increase structural support requirements
- Existing buildings may not be able to support increased load
- Will likely require irrigation during establishment (typically first 2 years) and dry seasons
- Requires increased maintenance compared to a conventional roof
- Higher cost than other GI technologies

## Siting Applications

- Commercial, industrial, and large residential buildings
- Public spaces like libraries and museums
- Urban areas with limited space and/or minimal vegetation

## Technical Information

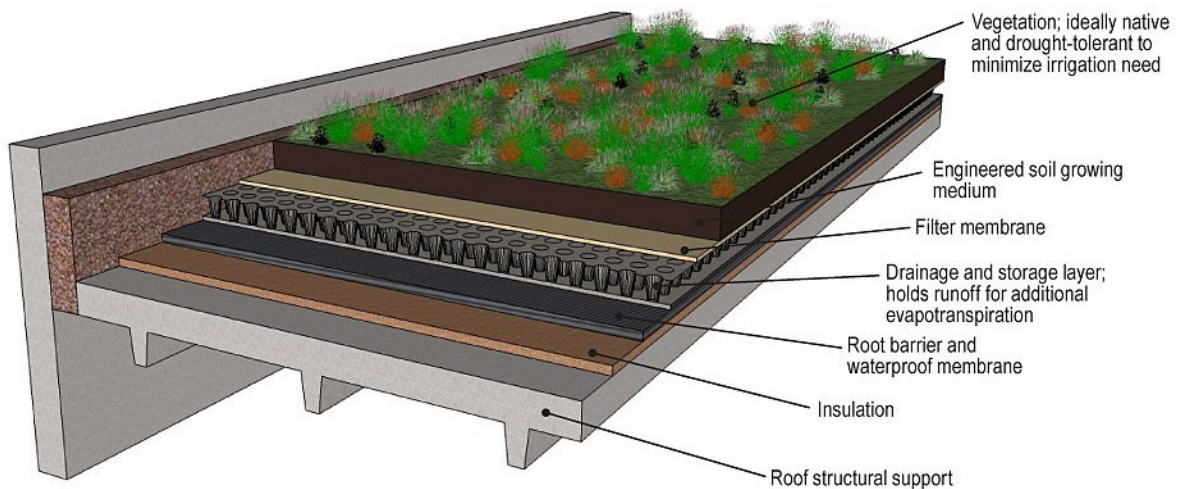

Figure: Green roof typical detail

### Design & Sizing Criteria

- Green roofs are flow-based systems designed to treat the rainfall that falls directly onto the vegetated area.
- Runoff from rooftop areas that are not part of the vegetated system (such as spaces for mechanical or ventilation equipment) will likely need to be routed to treatment areas on the ground.
- Green roofs are generally classified as either extensive or intensive. Extensive green roofs generally have six inches or less of soil media, use smaller plants, are lower maintenance, and are typically not intended to be accessible. Intensive green roofs have greater than six inches of soil, larger plants, greater structural and maintenance requirements, and are often designed as rooftop gardens or park-like settings for use by people.
- They are most suitable for flat roofs or those with slopes less than 20 degrees. Extensive green roofs can be constructed on slopes up to 40 degrees with specialized designs.
- A new or retrofit building must be designed to support the weight of the green roof when all layers and vegetation are fully saturated. This wet weight can be up to 6 or 7 pounds per square foot per inch of soil depth.
- A waterproof membrane is needed to protect the roof structure and a root barrier can be installed to protect the membrane. Insulation, if included, can be installed either above or below the waterproof membrane.



### Pollutant removal

- Remove suspended solids by infiltration and adsorption to porous media, nutrient uptake by plants.
- Plant cover intercepts rain and solar radiation.
- Vegetation traps particulates from roof (dirt, bird droppings, etc.).
- Evapotranspiration adds moisture.

### Water quality considerations

- Water retention can vary, depending on roof configuration.
- Green roof can act as a source of pollutants in dry climates.
- Outflow from roof is suitable for non-potable uses such as landscape irrigation.

### Performance

- No influent data for total phosphorus and total suspended solids.
- Effective removal for E. Coli in Oregon.

#### GREEN ROOF MONITORING RESULTS FROM 2016 SUMMARY STATISTICS (ISW DATABASE QUERY AUGUST 2019)

	E. COLI (CFU/100 ML)	TOTAL PHOSPHORUS (MG/L)	TOTAL NITROGEN (MG/L)	TOTAL SUSPENDED SOLIDS (MG/L)
Inflow*	291 (27.8-1260, n=5)	0.057 (0.0378-0.1, n=10)	0.0453 (0.02-0.081, n=3)	5.02 (2-12.3, n=9)
Outflow*	52 (11.5-185, n=5)	0.435 (0.32-0.847, n=10)	1.87 (1.27-3.25, n=3)	5 (3-10, n=9)

\*Inflow and Outflow are median values (interquartile range, sample size).

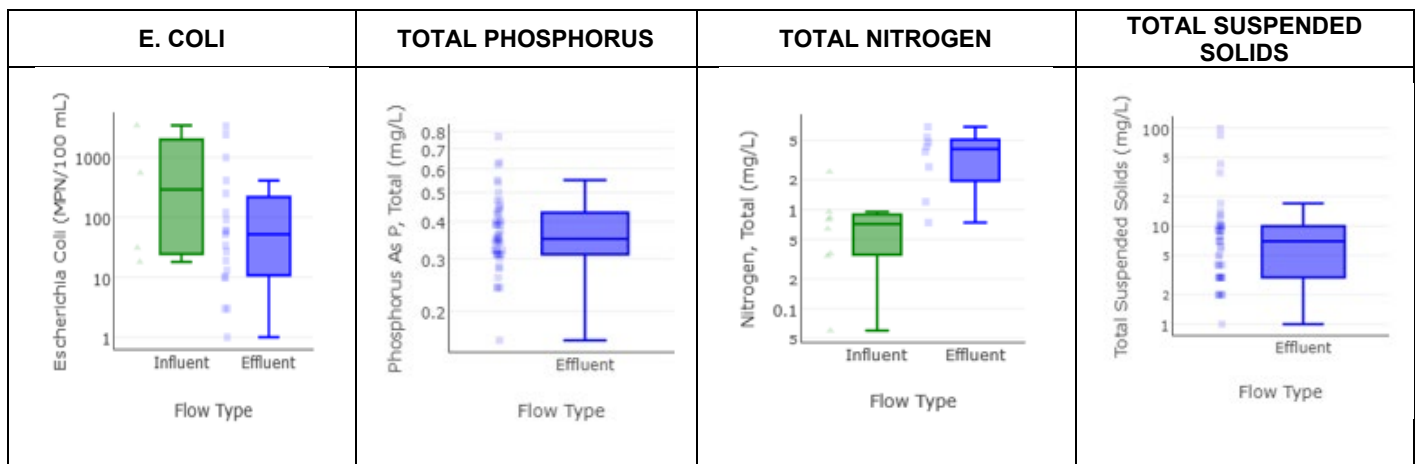

Results of green roof monitoring in Colorado for total phosphorus, and total suspended solids. Total nitrogen monitoring from North Carolina. E.coli monitoring from Oregon.